





PALOMA[®]
ITALY

Excellent
Lock Hardware





WWW.PALOMAHARDWARE.COM

ITALIAN PULL HANDLE MANUFACTURING PROCESS



Temporary Sand Moulding



Raw Brass



Brass Smelting



Brass Casting



Finished Product



Automatic Electroplating



Manual Polishing



Automatic Polishing

MADE IN ITALY



MATERIAL SELECTION STANDARD

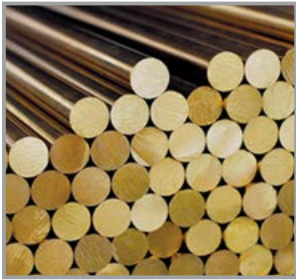

High Quality Brass

High quality brass with the best resistance to rust and corrosion (grade: CZ 122, CZ 121, C 3710).



World Class Stainless Steel

Stainless steel with high nickel and chromium content (grade: SUS 316, SUS 304).

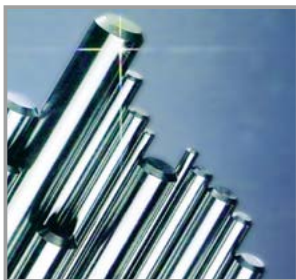

High Purity Australian Zinc

Zinc material with a purity level of 99.995% is imported directly from Australia (grade: Zamak-5, Zamak-3).



High Strength Aluminium

Aluminium for architectural and aviation structures, stronger but still lightweight (grade 6063, 6061).

SEVEN LAYERS ELECTROPLATING TECHNOLOGY

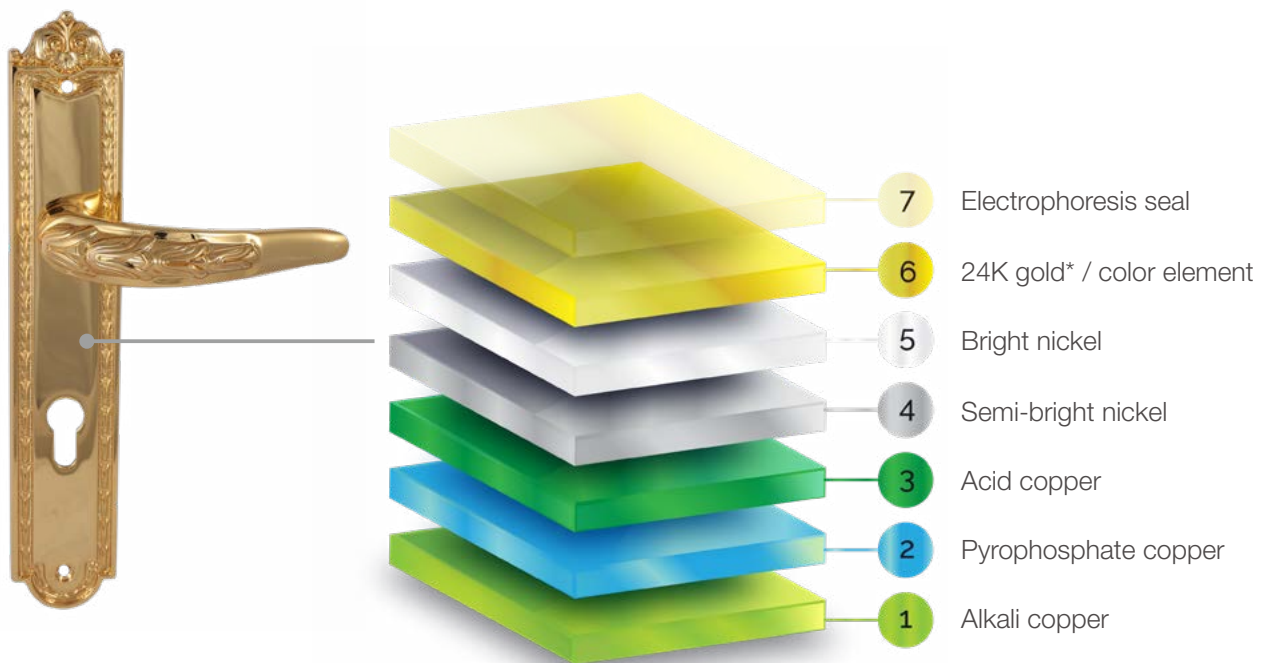

*24K gold only for products with Gold Plated finish (GP)

Main Features

- The best and leading electroplating technology.
- 7 extra thick and strong layers.
- Strong & anti-peeling.
- Additional protection against rust & corrosion.

10 MECHANICAL
YEARS WARRANTY

EURO-PROFILE MORTISE LOCK

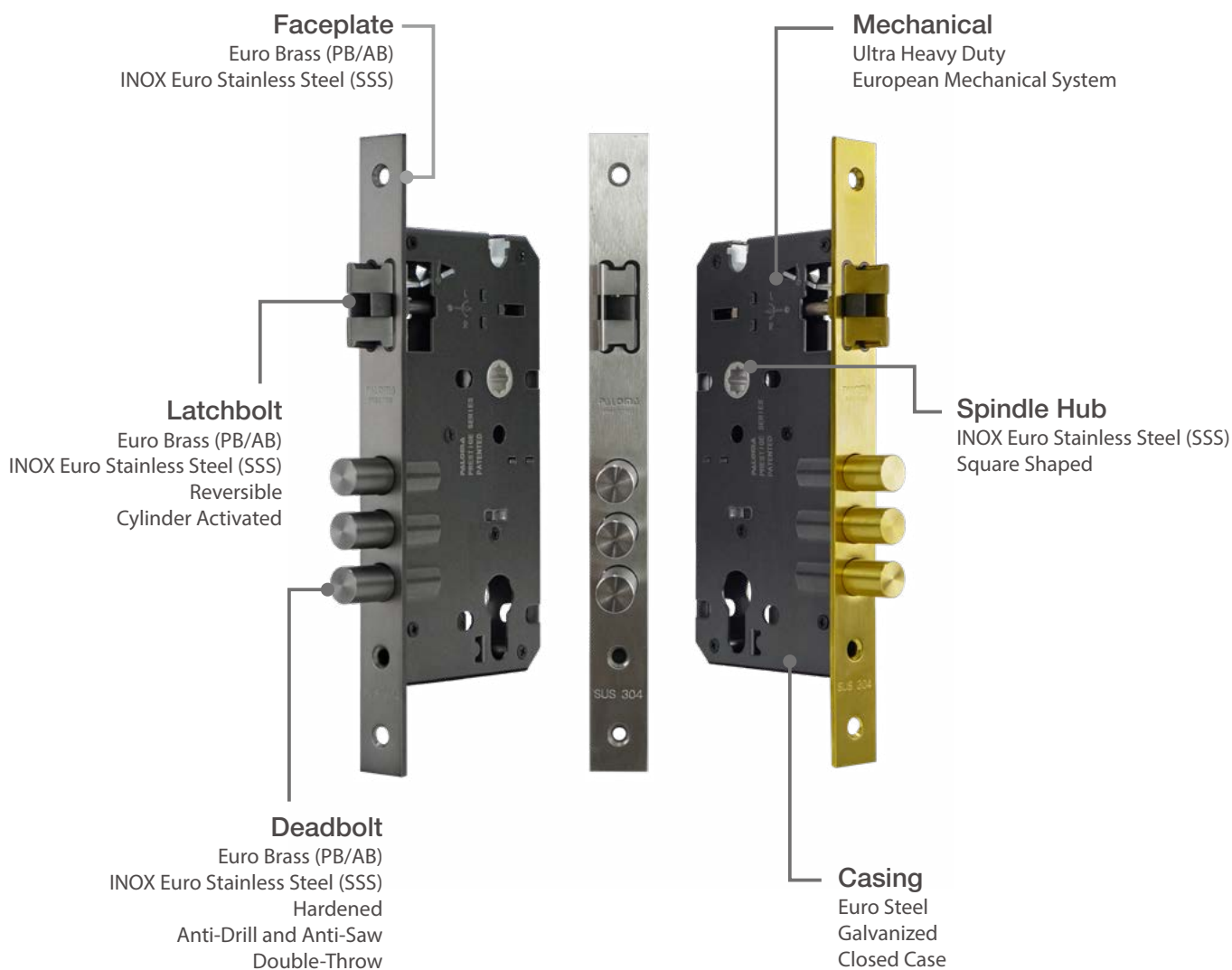

Main Features

- The highest quality, original made in Italy mortise lock.
- Maximum security, anti-drill and anti-saw deadbolt.
- Ultra heavy duty, passed 250000 test cycles.
- Fire-resistant, suitable for fire/smoke resistant door.
- High resistance against rust and corrosion.
- Designed and tested according to European standards.
- Comply with EN 12202:05 and ICIM 70R029.

MADE IN ITALY



**LIFETIME
MECHANICAL
WARRANTY**



EURO-PROFILE CYLINDER



Main Features

- The highest quality, original made in Italy cylinder.
- Maximum security, with anti-drill body and pick-resistant pins.
- Ultra heavy duty, passed 100000 test cycles.
- Fire-resistant, suitable for fire/smoke resistant door.
- High resistance against rust and corrosion.
- Designed and tested according to European standards.
- Comply with EN 1303:05 and ICIM 70R009.

MADE IN ITALY

 **LIFETIME
MECHANICAL
WARRANTY**

THE HIGHEST QUALITY HINGES



Main Features

- Full stainless steel material, high grade SUS 304+ Nickel 8%+ (highly corrosion resistant) Chromium 18%+ (highly corrosion resistant).
- European certificate EN1935 grade 13 (maximum grade 14). Exceeds 200,000x open-close test.
- Fire retardant as per European certificate EN1634.
- Can be used on fire and smoke arrestor emergency doors.
- Best quality original ball bearings.
- Extra security with Non Removeable Pin (NRP).
- SUS 304 stainless steel screw.
- 25 years mechanical warranty.

THE HIGHEST QUALITY ULTRAMARINE PADLOCK

Main Features

- Full stainless steel SUS 316 body and shackle (hardened).
- Computer key with 10 dimples.
- Cylinder with 10 Pins.
- Double ball locking system.
- Anti-Rust and Anti-Corrosion.
- Anti-Break and Anti-Shatter.
- Anti-Cut and Anti-Saw.
- Anti-Acid and Anti-Saline.
- Anti-Bump and Anti-Shock.
- Anti-Drill and Anti-Pick.
- Lifetime mechanical warranty.



FINISHES INDEX

Made in Italy Finishing Code :

AB	Antique Bronze (Bronzato)	OLV	Brass Polished (Ottone Lucido Verniciato)
ACL	Aluminium Polished Chrome (Alluminio Cromo Lucido)	ONO	Brass Black Matt (Ottone Nero Opaco)
ACP	Aluminium Satin Chrome Pearl (Alluminio Cromo Perla)	OV	Antique Gold (Oro Vecchio)
ANO	Aluminium Black Matt Textured (Alluminio Nero Apaco)	PC	Polished Chrome (Cromo Lucido)
CBI	Chrome-White For Aluminium (Cromo-Bianco)	PCS	Power Satin Chrome (Power Cromosat)
CCS	Chrome-Power Satchrome (Cromo-Power Cromosat)	PVD	Gold (Oro)
CNE	Chrome-Black For Aluminium (Cromo-Nero)	PVX	Steel (Inox)
GP	Gold Plated (Bagno Oro)	SC	Satin Chrome (Satinato Cromo)
GR	Scratched Bronze (Bronzo Graffiato)	YB	Yester Bronze (Bronzo Yester)
GS	Gold Plated + Sand (Oro + Oro Sabbiato)	ZC	Chrome For Zinc Alloy (Cromo)
OBN	Brass White (Ottone Bianco)	ZCBI	Zinc Alloy Chrome-White (Zalor Cromo-White)
OC	Chrome For Brass (Cromo)	ZCCS	Zinc Alloy Chrome-Satin Chrome (Zalor Cromo-Cromosat)
OCL	Brass Polished Chrome (Ottone Cromo Lucido)	ZCL	Zinc Alloy Chrome Plated (Zalor Cromo Lucido)
OCS	Brass Satin Chrome (Ottone Cromo Satinato)	ZCNE	Zinc Alloy Chrome-Black For Zamak (Zalor Cromo-Nero)
OGH	Brass Satin Bronze (Ottone Bronzosat)	ZCS	Zinc Alloy Satin Chrome (Zalor Cromo Satinato)
OGS	Brass Satin Graphite (Ottone Grafite Satinato)	ZNE	Black For Zinc Alloy (Nero)

Others Finishing Code :

AB	Antique Brass
AC	Antique Copper
AMB	Amber Brass
BA	Black Anodized
BUB	Brass Under Bronze
CF	Coffee
CH/CP	Chrome / Chrome Plated
DW	Dark Wood
GB	Grey Brass
GM	Gunmetal
GP	Gold Plated
IA	Italian Antique
MAC	Matte Antique Copper
MB	Matte Brass
MBL	Matte Black
MWH	Matte White
NA	Natural Anodized
NP	Nickel Polished
PB	Polished Brass
PSS	Polished Stainless Steel
PVD	Physical Vapour Deposition
RAB	Real Antique Brass
RAC	Real Antique Copper
SB	Satin Brass
SC	Satin Chrome
SG	Satin Gold
SN	Satin Nickel
SSS	Satin Stainless Steel
WH	White

Superalum Finishing Code :

BSN	Brushed Satin Nickel
CCP	Chocolate Painting
MAB	Matte Antique Brass
MAC	Matte Antique Copper
MBN	Matte Black Nickel
WBL	Wood Black
WBR	Wood Brown
WCR	Wood Cream
WRE	Wood Red
WWH	Wood White

CONTENTS



PULL HANDLE
MADE IN ITALY
EURO BRASS

Page 15



PULL HANDLE
BRASS

Page 21



PULL HANDLE
SOLID
STAINLESS
STEEL SUS 304

Page 25



PULL HANDLE
TUBE
STAINLESS
STEEL

Page 29



PULL HANDLE
TUBE
STAINLESS
STEEL + WOOD

Page 41



PULL HANDLE
SUPERALUM

Page 45



PULL HANDLE
ZAMAK ALLOY

Page 57



SMART
DIGITAL LOCK

Page 63



LEVER HANDLE
PLATE BRASS

Page 73



LEVER HANDLE
PLATE
STAINLESS
STEEL SUS 304

Page 77



LEVER HANDLE
PLATE
ZAMAK ALLOY

Page 81



HANDLE
ENTRANCE
BRASS

Page 87



LEVER HANDLE
ROSES BRASS

Page 91



LEVER HANDLE
ROSES
7 LAYERS BRASS

Page 97



LEVER HANDLE
ROSES SOLID
STAINLESS
STEEL SUS 304

Page 101



LEVER HANDLE
ROSES TUBE
STAINLESS STEEL

Page 105



LEVER HANDLE
ROSES ZAMAK
ALLOY

Page 113



LEVER HANDLE
ROSES ZAMAK
ALLOY +
ALUMINIUM

Page 119



LEVER HANDLE
ROSES
SUPERALUM LITE

Page 123



MAGNETIC
DOOR LOCK SET

Page 131

CONTENTS

			
DOOR LOCK KNOB	SLIDING DOOR LOCK	HANDLE FURNITURE	ESCUTCHEON
Page 135	Page 139	Page 145	Page 149
			
MORTISE LOCK	CYLINDER	HINGES	DOOR ACCESSORIES
Page 155	Page 171	Page 181	Page 197



WINDOW
ACCESSORIES

Page 213



PADLOCK

Page 225

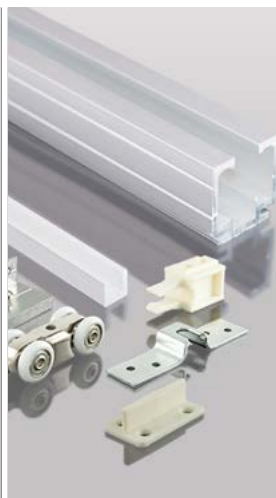

SLIDING RAIL

Page 229



PANIC EXIT
DEVICE

Page 235

PULL HANDLE
MADE IN ITALY
EURO BRASS







Pull handle Allegra

- made in Italy
- euro brass



PHP 9101
(545MM, GP)



PHP 9102
(545MM, OV)

Pull handle Nicole

- made in Italy
- euro brass



PHP 9104
(895MM, GP)



PHP 9105
(895MM, OV)

Pull handle Nettuno

- made in Italy
- euro brass



PHP 9107
(735MM, GP)



PHP 9108
(735MM, OV)

Pull handle Modulo

- made in Italy
- euro brass



PHP 9110
(455MM, GP)



PHP 9111
(455MM, OV)

Pull handle Tiziana

- made in Italy
- euro brass



PHP 9113
(715MM, GP)



PHP 9114
(715MM, GR)

Pull handle Galassia

- made in Italy
- euro brass



PHP 9116
(660MM, GP+GS)



PHP 9117
(660MM, YB)

Pull handle Caserta

- made in Italy
- euro brass



PHP 9119
(410MM, GP+GS)



PHP 9120
(410MM, YB)

Pull handle Milena

- made in Italy
- euro brass



PHP 9122
(585MM, GP)



PHP 9123
(585MM, YB)

Pull handle Prato Z

- made in Italy
- euro brass



PHP 9125
(480MM, GP)



PHP 9126
(480MM, YB)

Pull handle Imola Z

- made in Italy
- euro brass



PHP 9128
(470MM, GP)



PHP 9129
(470MM, YB)

Pull handle Monza Z

- made in Italy
- euro brass



PHP 9131
(470MM, GP)



PHP 9132
(470MM, YB)

Pull handle Alina

- made in Italy
- euro brass



PHP 9134
(695MM, GP+GS)



PHP 9135
(695MM, YB)

Pull handle Eolica

- made in Italy
- euro brass



PHP 9137
(438MM, GP+GS)



PHP 9138
(438MM, YB)

Pull handle Salerno

- made in Italy
- euro brass



PHP 9140
(690MM, GP+GS)



PHP 9141
(690MM, YB)

Pull handle Pesaro

- made in Italy
- euro brass



PHP 9143
(430MM, GP+GS)



PHP 9144
(430MM, YB)

PULL HANDLE BRASS



PULL HANDLE BRASS

Pull handle Safira

· euro brass



PHP 6001
(439MM, 24KGold)



PHP 6002
(439MM, RAB)

Pull handle Silvia

· euro brass



PHP 6003
(688MM, 24KGold)



PHP 6004
(688MM, RAB)

Pull handle Bianco

· brass



PHP 6101
(450MM, AB)



PHP 6102
(600MM, AB)

Pull handle Dragon

· brass



PHP 101
(310MM, GP)



PHP 102
(310MM, BUB)

PULL HANDLE BRASS

Pull handle Vienna

·brass



PHP 7101
(400MM, SB)



PHP 7102
(400MM, MBL)

Pull handle Vienna

·brass



PHP 7201
(650MM, SB)



PHP 7202
(650MM, MBL)



PALOMA[®]

HIGH QUALITY ARCHITECTURAL HARDWARE

PULL HANDLE

SOLID

STAINLESS STEEL

SUS 304





Pull handle Bianca

- solid stainless steel
- 750MM
- SUS 304

Available
PHP 2901 (SSS)



PHP 2902
(MBL)



PHP 2903
(GUNMETAL)

Pull handle Stormy

- solid stainless steel
- 863MM
- SUS 304

Available
PHP 2911 (SSS)



PHP 2912
(MBL)



PHP 2913
(GUNMETAL)

Pull handle Alessia

- solid stainless steel
- 365MM
- SUS 304



PHP 353
(365MM, PVD)



PHP 354
(365MM, SSS)

Pull handle Bella

- solid stainless steel
- 500MM
- SUS 304



PHP 351
(500MM, PVD)



PHP 352
(500MM, SSS)

PULL HANDLE
TUBE
STAINLESS STEEL







PULL HANDLE TUBE STAINLESS STEEL SUS 316

Pull handle Olympia

- thickness 1.5mm
- SUS 316
- PSS+SSS

Available
PHP 934 (900MM)
PHP 935 (1200MM)



PHP 931 (350MM) **PHP 932** (450MM) **PHP 933** (600MM)

Pull handle Bellini

- thickness 1.5mm
- SUS 316
- SSS

Available
PHP 948 (900MM)
PHP 949 (1200MM)
PHP 950 (1500MM)
PHP 951 (2000MM)



PHP 945 (350MM) **PHP 946** (450MM) **PHP 947** (600MM)

Pull handle Bellini

- thickness 1.5mm
- SUS 316
- PSS+SSS

Available
PHP 955 (900MM)
PHP 956 (1200MM)
PHP 957 (1500MM)
PHP 958 (2000MM)



PHP 952 (350MM) **PHP 953** (450MM) **PHP 954** (600MM)

Pull handle Ancona

- thickness 1.5mm
- SUS 316
- SSS

Available
PHP 969 (900MM)
PHP 970 (1200MM)
PHP 971 (1500MM)
PHP 972 (2000MM)



PHP 966 (350MM) **PHP 967** (450MM) **PHP 968** (600MM)

Pull handle Ancona

- thickness 1.5mm
- SUS 316
- PSS+SSS

Available
PHP 976 (900MM)
PHP 977 (1200MM)
PHP 978 (1500MM)
PHP 979 (2000MM)



PHP 973 (350MM) **PHP 974** (450MM) **PHP 975** (600MM)

Pull handle Alves

- thickness 1.5mm
- SUS 316
- SSS

Available
PHP 986 (900MM)
PHP 987 (1200MM)
PHP 988 (1500MM)
PHP 989 (2000MM)



PHP 983 (350MM) **PHP 984** (450MM) **PHP 985** (600MM)

Pull handle Rainier

- thickness 1.5mm
- SUS 316
- PSS+SSS

Available
PHP 1104 (900MM)
PHP 1105 (1200MM)



PHP 1101 (350MM) **PHP 1102** (500MM) **PHP 1103** (600MM)

Pull handle N-Bellini

- thickness 1.5mm
- SUS 316
- PSS+SSS

Available
PHP 1211 (900MM)
PHP 1212 (1200MM)



PHP 1208 (350MM) **PHP 1209** (500MM) **PHP 1210** (600MM)

PULL HANDLE TUBE STAINLESS STEEL SUS 304

Pull handle N-Adina

- thickness 1.25mm
- SUS 304
- PSS+SSS



PHP 274
(350MM)

PHP 275
(450MM)

PHP 276
(600MM)

Pull handle N-Corina

- thickness 1.25mm
- SUS 304
- PSS+SSS



PHP 277
(350MM)

PHP 278
(450MM)

PHP 279
(600MM)

Pull handle Sena

- thickness 1.25mm
- SUS 304
- PSS+SSS



PHP 304
(500MM)

PHP 305
(600MM)

PHP 306
(800MM)

Pull handle Olivia

- thickness 1.25mm
- SUS 304
- PSS+SSS

Available
PHP 310 (900MM)
PHP 311 (1200MM)



PHP 307
(350MM)

PHP 308
(500MM)

PHP 309
(600MM)

Pull handle Moneta

- thickness 1.25mm
- SUS 304
- PSS+SSS



PHP 312
(350MM)

PHP 313
(500MM)

Pull handle N-Tosca

- thickness 1.25mm
- SUS 304
- PSS+SSS



PHP 280
(300MM)

Pull handle N-Leiva

- thickness 1.25mm
- SUS 304
- PSS+SSS



PHP 281
(300MM)

Pull handle N-Cavana

- thickness 1.25mm
- SUS 304
- PSS+SSS



PHP 282
(300MM)

Pull handle Stella

- thickness 1.25mm
- SUS 304
- PSS+SSS

Available

- PHP 317** (900MM)
- PHP 318** (1200MM)



PHP 314
(350MM)

PHP 315
(450MM)

PHP 316
(600MM)

Pull handle Ruby

- thickness 1.25mm
- SUS 304
- PSS+SSS

Available

- PHP 321** (1000MM)



PHP 319
(600MM)

PHP 320
(800MM)

Pull handle N-Corda

- thickness 1.25mm
- SUS 304
- SSS



PHP 324
(350MM)

PHP 325
(500MM)

PHP 326
(600MM)

Pull handle N-Omega

- thickness 1.25mm
- SUS 304
- PSS+SSS

Available

- PHP 332** (900MM)
- PHP 333** (1200MM)



PHP 329
(350MM)

PHP 330
(450MM)

PHP 331
(600MM)

Pull handle N-Tosca

- thickness 1.25mm
- SUS 304
- SSS

Available

- PHP 337** (900MM)
- PHP 338** (1200MM)



PHP 334
(350MM)

PHP 335
(500MM)

PHP 336
(600MM)

Pull handle N-Tosca

- thickness 1.25mm
- SUS 304
- PSS+SSS

Available

- PHP 342** (900MM)
- PHP 343** (1200MM)



PHP 339
(350MM)

PHP 340
(500MM)

PHP 341
(600MM)

PULL HANDLE TUBE STAINLESS STEEL SUS 304

Pull handle N-Elano

- thickness 1.25mm
- SUS 304
- SSS

Available
PHP 347 (900MM)
PHP 348 (1200MM)



Pull handle Kiwi

- thickness 1.25mm
- SUS 304
- SSS



PHP 323
(195MM)

Pull handle N-Modric

- thickness 1.25mm
- SUS 304
- PSS+SSS



Pull handle N-Leiva

- thickness 1.25mm
- SUS 304
- PSS+SSS

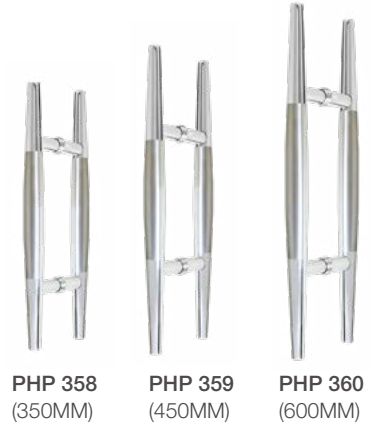

Pull handle N-Garda

- thickness 1.25mm
- SUS 304
- SSS



Pull handle N-Capri

- thickness 1.25mm
- SUS 304
- SSS

Available
PHP 369 (900MM)
PHP 370 (1200MM)



Pull handle N-Cavana

- thickness 1.25mm
- SUS 304
- SSS

Available
PHP 379 (900MM)
PHP 380 (1200MM)



Pull handle N-Cavana

- thickness 1.25mm
- SUS 304
- PSS+SSS

Available
PHP 384 (900MM)
PHP 385 (1200MM)



PULL HANDLE TUBE STAINLESS STEEL SUS 304

Pull handle N-Vidic

- thickness 1.25mm
- SUS 304
- PSS+SSS



PHP 386
(350MM)

PHP 387
(500MM)

PHP 388
(600MM)

Pull handle N-Borini

- thickness 1.25mm
- SUS 304
- PSS+SSS

Available
PHP 392 (900MM)
PHP 393 (1200MM)



PHP 389
(350MM)

PHP 390
(500MM)

PHP 391
(600MM)

Pull handle Epsom

- thickness 1.25mm
- SUS 304



PHP 399
(350MM, PSS)

PHP 400
(350MM, MBL)

Pull handle Roland

- thickness 1.25mm
- SUS 304
- PSS



PHP 398
(300MM)

Pull handle N-Cosmo

- thickness 1.25mm
- SUS 304
- PSS



PHP 394
(300MM)

PHP 395
(350MM)

PHP 396
(400MM)

PHP 397
(500MM)

Pull handle Cavana

- thickness 1.25mm
- SUS 304
- satin gold

Available
PHP 3204 (600MM)
PHP 3205 (900MM)
PHP 3206 (1200MM)
PHP 3207 (1500MM)
PHP 3208 (2000MM)



PHP 3201
(300MM)

PHP 3202
(400MM)

PHP 3203
(500MM)

PULL HANDLE TUBE STAINLESS STEEL SUS 304

Pull handle Cavana

- thickness 1.25mm
- SUS 304
- matte black

Available

- PHP 3104 (600MM)
- PHP 3105 (900MM)
- PHP 3106 (1200MM)
- PHP 3107 (1500MM)
- PHP 3108 (2000MM)



Pull handle Tosca

- thickness 1.25mm
- SUS 304
- matte black

Available

- PHP 3114 (600MM)
- PHP 3115 (900MM)
- PHP 3116 (1200MM)
- PHP 3117 (1500MM)
- PHP 3118 (2000MM)

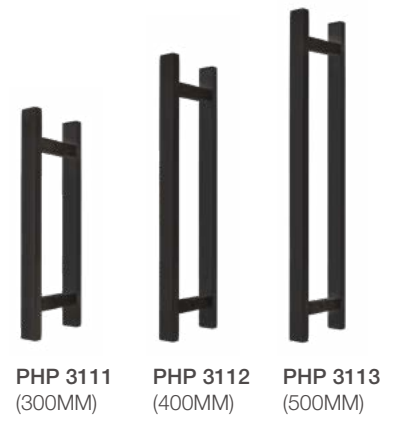

Pull handle Leiva

- thickness 1.25mm
- SUS 304
- matte black

Available

- PHP 3124 (600MM)
- PHP 3125 (900MM)
- PHP 3126 (1200MM)



Pull handle Capri

- thickness 1.25mm
- SUS 304
- matte black

Available

- PHP 3134 (900MM)
- PHP 3135 (1200MM)
- PHP 3136 (1500MM)
- PHP 3137 (2000MM)



Pull handle Cavana

- thickness 1.25mm
- SUS 304
- gunmetal

Available

- PHP 3304 (600MM)
- PHP 3305 (900MM)
- PHP 3306 (1200MM)
- PHP 3307 (1500MM)
- PHP 3308 (2000MM)



Pull handle Capri

- thickness 1.25mm
- SUS 304
- gunmetal

Available

- PHP 3334 (900MM)
- PHP 3335 (1200MM)
- PHP 3336 (1500MM)
- PHP 3337 (2000MM)



Pull handle Tosca

- thickness 1.25mm
- SUS 304
- gunmetal

Available

- PHP 3314 (600MM)
- PHP 3315 (900MM)
- PHP 3316 (1200MM)
- PHP 3317 (1500MM)
- PHP 3318 (2000MM)



Pull handle Leiva

- thickness 1.25mm
- SUS 304
- gunmetal

Available

- PHP 3324 (600MM)
- PHP 3325 (900MM)
- PHP 3326 (1200MM)

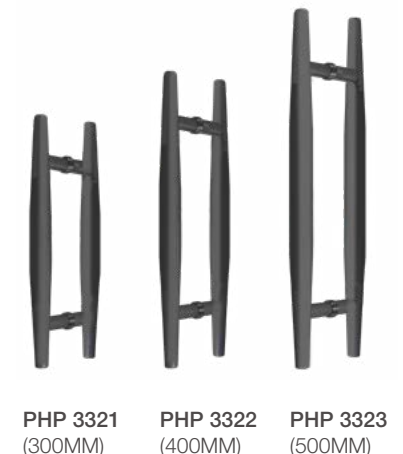

PULL HANDLE TUBE STAINLESS STEEL

Pull handle Vivian

- SUS 304
- PSS+LW

Available

- PHP 2128 (600MM)
- PHP 2129 (900MM)
- PHP 2130 (1200MM)



PHP 2125
(300MM)



PHP 2126
(350MM)



PHP 2127
(450MM)

Pull handle Vivian

- SUS 304
- PSS+DW

Available

- PHP 2140 (600MM)
- PHP 2141 (900MM)
- PHP 2142 (1200MM)



PHP 2137
(300MM)



PHP 2138
(350MM)



PHP 2139
(450MM)

Pull handle Tosca

- SUS 304
- PSS+LW

Available

- PHP 2228 (600MM)
- PHP 2229 (900MM)
- PHP 2230 (1200MM)



PHP 2225
(300MM)



PHP 2226
(350MM)



PHP 2227
(450MM)

Pull handle Tosca

- SUS 304
- PSS+DW

Available

- PHP 2240 (600MM)
- PHP 2241 (900MM)
- PHP 2242 (1200MM)



PHP 2237
(300MM)



PHP 2238
(350MM)



PHP 2239
(450MM)

Pull handle Leiva

- SUS 304
- PSS+LW

Available

- PHP 2328 (600MM)
- PHP 2329 (900MM)
- PHP 2330 (1200MM)



PHP 2325
(300MM)



PHP 2326
(350MM)



PHP 2327
(450MM)

Pull handle Leiva

- SUS 304
- PSS+DW

Available

- PHP 2340 (600MM)
- PHP 2341 (900MM)
- PHP 2342 (1200MM)



PHP 2337
(300MM)



PHP 2338
(350MM)



PHP 2339
(450MM)



PULL HANDLE
TUBE
STAINLESS STEEL
+ WOOD





PULL HANDLE TUBE STAINLESS STEEL + WOOD

Pull handle Stella

- SUS 304 + wood
- PSS+DW

Available

- PHP 604 (900MM)
- PHP 605 (1200MM)



PHP 601
(350MM)

PHP 602
(450MM)

PHP 603
(600MM)

Pull handle Olivia

- SUS 304 + wood
- PSS+DW

Available

- PHP 609 (900MM)
- PHP 610 (1200MM)



PHP 606
(350MM)

PHP 607
(500MM)

PHP 608
(600MM)

Pull handle Ruby

- SUS 304 + wood
- PSS+DW

Available

- PHP 613 (1000MM)



PHP 611
(600MM)

PHP 612
(800MM)

Pull handle Ebano

- SUS 304 + wood
- PSS+DW

Available

- PHP 616 (1000MM)



PHP 614
(600MM)

PHP 615
(800MM)

Pull handle Odessa

- SUS 304 + wood
- SSS+DW

Available

- PHP 619 (1000MM)



PHP 617
(600MM)

PHP 618
(800MM)

Pull handle Idra

- SUS 304 + wood
- SSS+DW

Available

- PHP 624 (1000MM)



PHP 621
(450MM)

PHP 622
(600MM)

PHP 623
(800MM)

Pull handle Destello

- SUS 304 + wood
- PSS+DW



PHP 620
(600MM)

PULL HANDLE SUPERALUM







PULL HANDLE SUPERALUM

Pull handle Tivoli

- aluminium
- MBN



PHP 8002 (280MM) PHP 8007 (420MM)

Pull handle Tivoli

- aluminium
- MAB



PHP 8004 (280MM) PHP 8009 (420MM)

Pull handle Imola

- aluminium
- MBN



PHP 8017 (280MM) PHP 8022 (420MM)

Pull handle Imola

- aluminium
- MAB



PHP 8019 (280MM) PHP 8024 (420MM)

Pull handle Prato

- aluminium
- MBN



PHP 8032 (280MM) PHP 8037 (420MM)

Pull handle Prato

- aluminium
- MAB



PHP 8034 (280MM) PHP 8039 (420MM)

Pull handle Severo

- aluminium
- BSN



PHP 8046 (280MM) PHP 8051 (420MM)

Pull handle Severo

- aluminium
- MAB



PHP 8049 (280MM) PHP 8054 (420MM)

PULL HANDLE SUPERALUM

Pull handle Teramo

- aluminium
- BSN



PHP 8061
(280MM)

PHP 8066
(420MM)

Pull handle Teramo

- aluminium
- MAB



PHP 8064
(280MM)

PHP 8069
(420MM)

Pull handle Monza

- aluminium
- MAC



PHP 8078
(280MM)

PHP 8083
(420MM)

Pull handle Monza

- aluminium
- MAB



PHP 8079
(280MM)

PHP 8084
(420MM)

Pull handle Ascoli

- aluminium
- MBN



PHP 8092
(280MM)

PHP 8097
(420MM)

PHP 8102
(650MM)

Pull handle Ascoli

- aluminium
- MAB

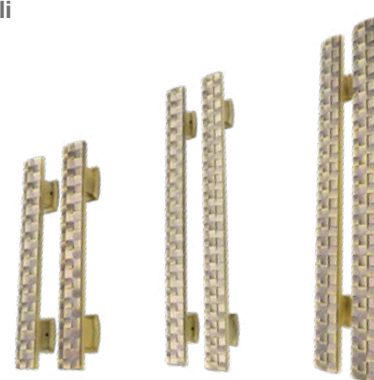

PHP 8094
(280MM)

PHP 8099
(420MM)

PHP 8104
(650MM)

Pull handle Caserta

- aluminium
- MBN



PHP 8107
(280MM)

PHP 8112
(420MM)

PHP 8117
(650MM)

Pull handle Caserta

- aluminium
- MAB

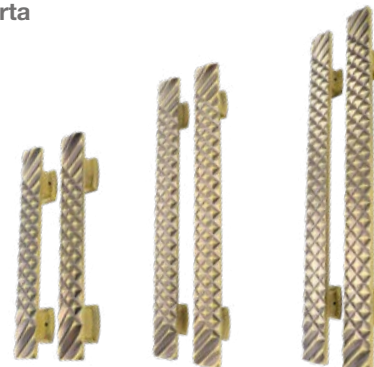

PHP 8109
(280MM)

PHP 8114
(420MM)

PHP 8119
(650MM)

PULL HANDLE SUPERALUM

Pull handle Genova

- aluminium
- BSN



Pull handle Genova

- aluminium
- MAB



Pull handle Catania

- aluminium
- MAC

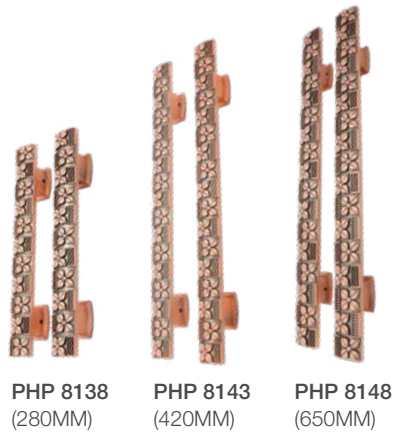

Pull handle Catania

- aluminium
- MAB

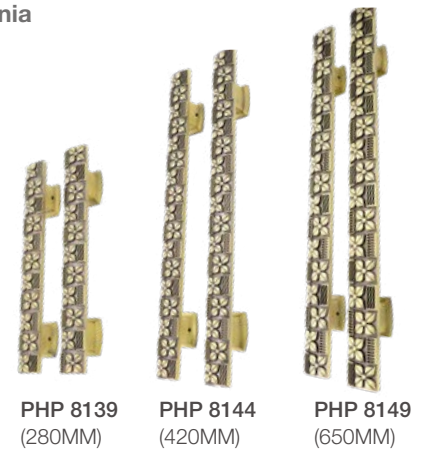

Pull handle Anzio

- aluminium
- BSN+CCP



Pull handle Carpi

- aluminium
- BSN+WBL



Pull handle Carpi

- aluminium
- BSN+WBR



Pull handle Carpi

- aluminium
- BSN+WCR



PULL HANDLE SUPERALUM

Pull handle Carpi

- aluminium
- BSN+WRE



PHP 8169
(280MM)



PHP 8174
(420MM)



PHP 8179
(650MM)

Pull handle Carpi

- aluminium
- BSN+WWH



PHP 8170
(280MM)



PHP 8175
(420MM)



PHP 8180
(650MM)

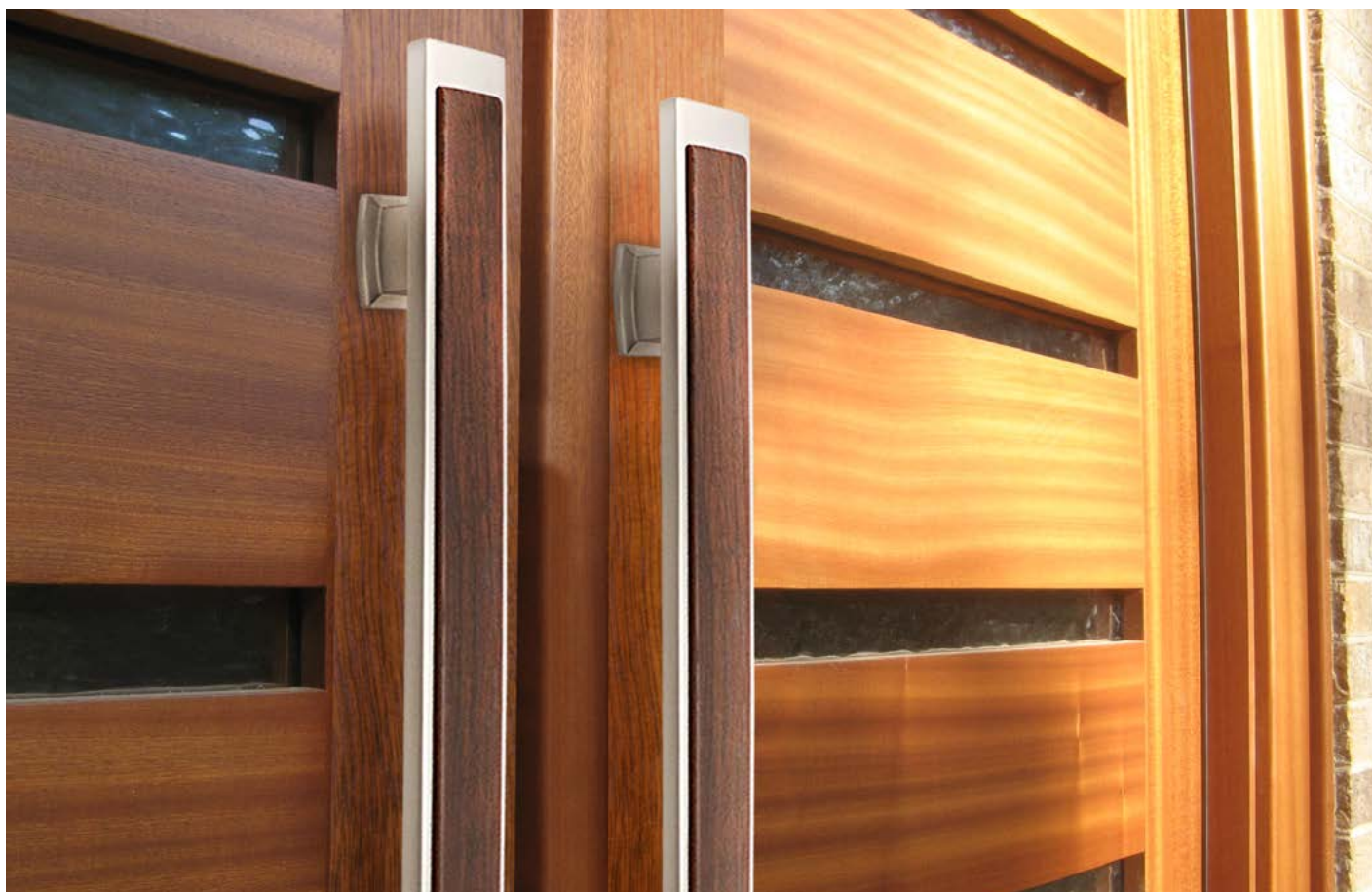

PULL HANDLE SUPERALUM

Pull handle Casoria

- superalum
- 600MM



Pull handle Casoria

- superalum
- 800MM



Pull handle Casoria

- superalum
- 1000MM



PULL HANDLE SUPERALUM

Pull handle Potenza

- superalum
- 600MM



PHP 8311
(SAND GOLD)



PHP 8312
(MBL)



PHP 8313
(GUNMETAL)



PHP 8314
(WHITE)



PHP 8315
(SN)



PHP 8316
(AC)



PHP 8317
(AB)



PHP 8318
(MATTE
ROSE GOLD)



PHP 8319
(OLD IRON)

Pull handle Potenza

- superalum
- 800MM



PHP 8321
(SAND GOLD)



PHP 8322
(MBL)



PHP 8323
(GUNMETAL)



PHP 8324
(WHITE)



PHP 8325
(SN)



PHP 8326
(AC)



PHP 8327
(AB)



PHP 8328
(MATTE
ROSE GOLD)



PHP 8329
(OLD IRON)

Pull handle Potenza

- superalum
- 1000MM



PHP 8331
(SAND GOLD)



PHP 8332
(MBL)



PHP 8333
(GUNMETAL)



PHP 8334
(WHITE)



PHP 8335
(SN)



PHP 8336
(AC)



PHP 8337
(AB)



PHP 8338
(MATTE
ROSE GOLD)



PHP 8339
(OLD IRON)

PULL HANDLE SUPERALUM

Pull handle Centurion

- superalum
- 480MM



PHP 8611 (PVD GOLD) PHP 8612 (MBL) PHP 8613 (MAB) PHP 8615 (MSN)

Pull handle Centurion

- superalum
- 800MM



PHP 8621 (PVD GOLD) PHP 8622 (MBL) PHP 8623 (MAB) PHP 8625 (MSN)

Pull handle Domus

- superalum
- 500MM



PHP 8601 (PVD GOLD) PHP 8602 (MBL) PHP 8603 (MAB)

Pull handle Verdant

- superalum
- 800MM



PHP 8632 (MBL) PHP 8633 (MAB)

Pull handle Simplu

- superalum
- 600MM



PHP 8642 (MBL) PHP 8645 (MSN)

Pull handle Simplu

- superalum
- 800MM

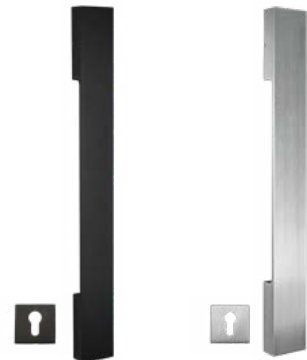

PHP 8652 (MBL) PHP 8655 (MSN)

PULL HANDLE SUPERALUM

Pull handle Semicerc

- superalum
- 300MM



PHP 8662
(MBL)



PHP 8664
(MCF)

Pull handle Trava

- superalum
- 480MM



PHP 8671
(PVD GOLD)



PHP 8672
(MBL)



PHP 8675
(MSN)

Pull handle Trava

- superalum
- 600MM



PHP 8681
(PVD GOLD)



PHP 8682
(MBL)



PHP 8685
(MSN)

Pull handle Trava

- superalum
- 800MM



PHP 8691
(PVD GOLD)



PHP 8692
(MBL)



PHP 8695
(MSN)

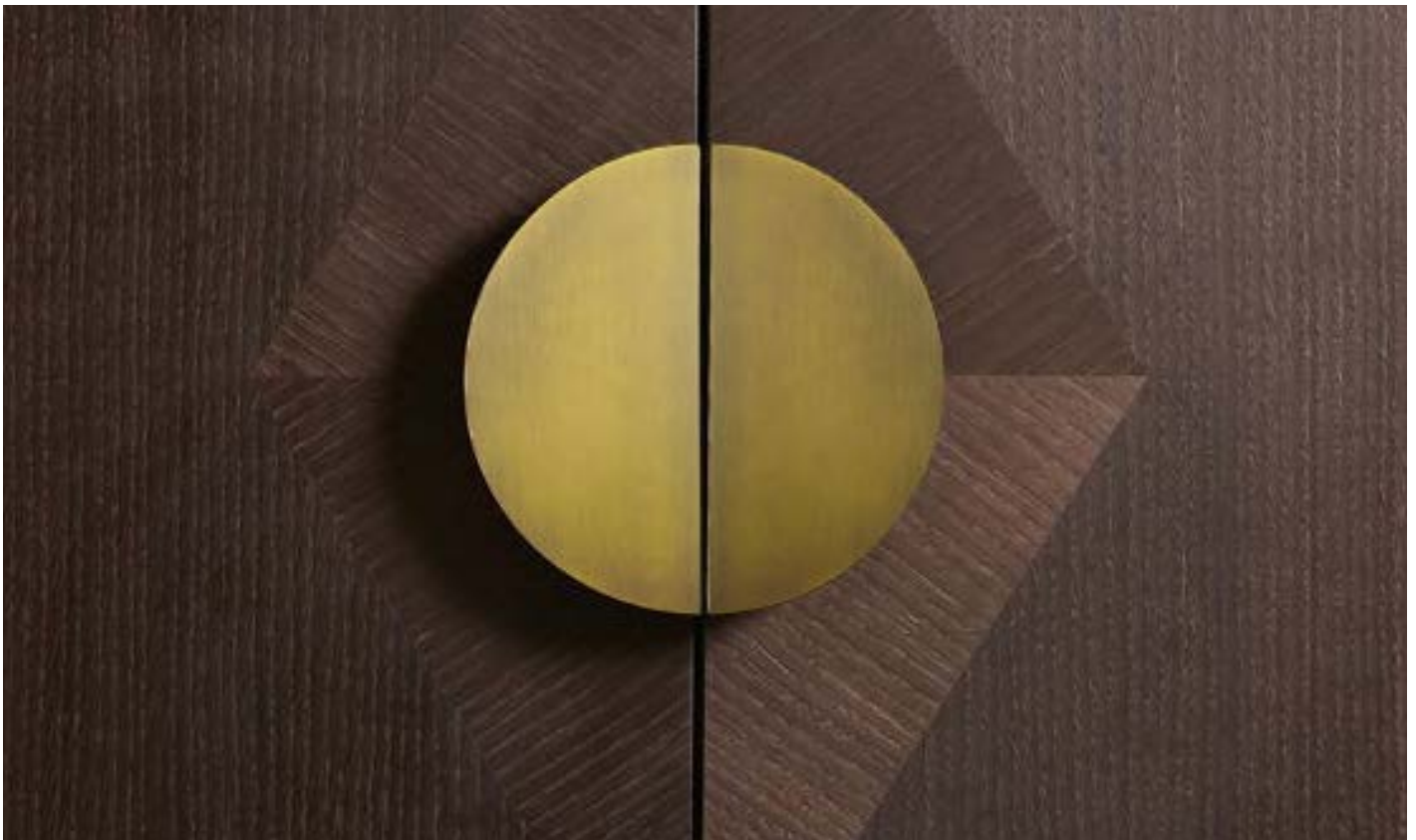

PULL HANDLE
ZAMAK ALLOY





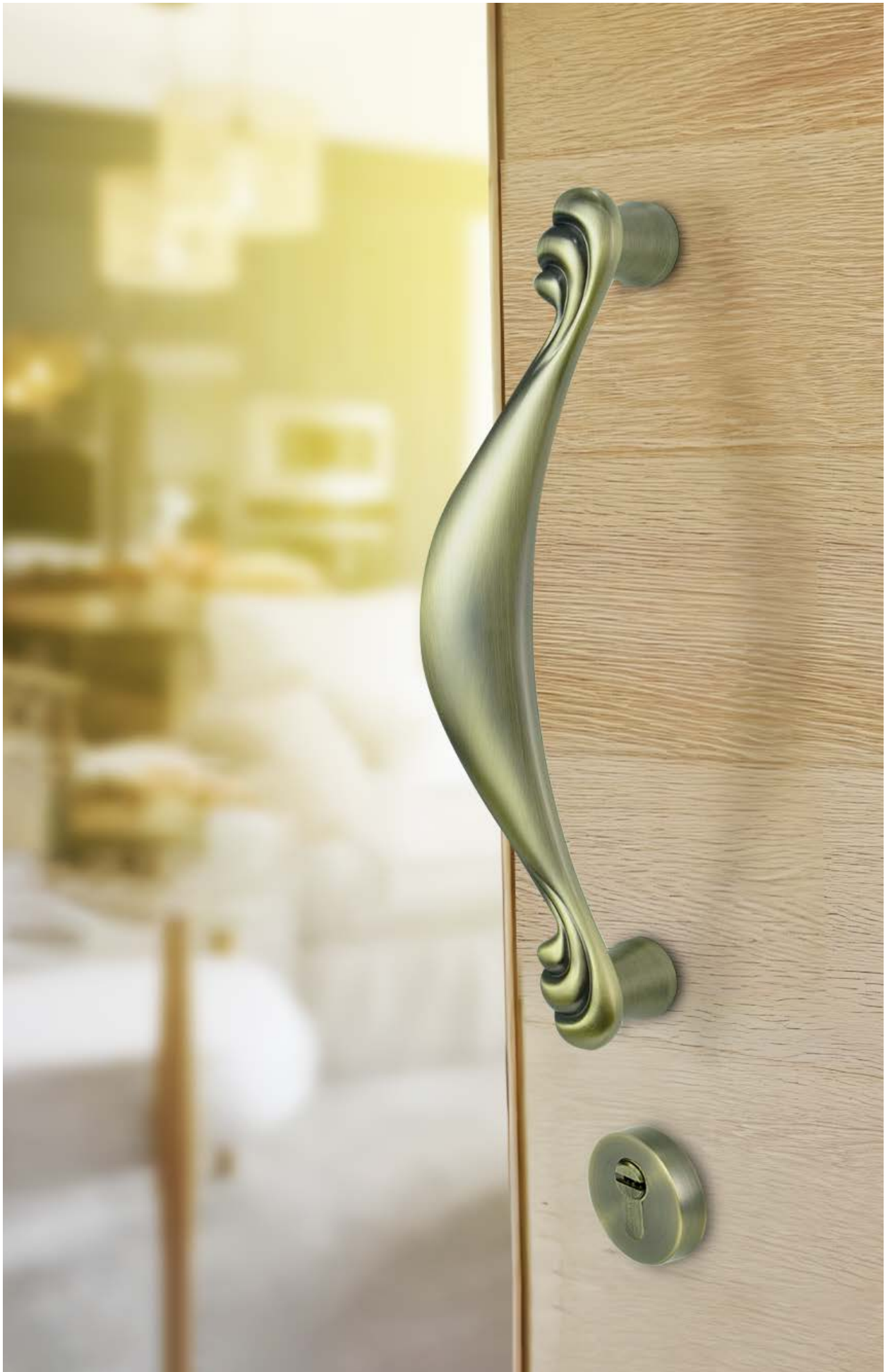

PULL HANDLE ZAMAK ALLOY

Pull handle Gulliver

- Zamak Alloy
- 285MM



PHP 753
(MAB)

Pull handle Bastion

- Zamak Alloy
- 820MM



PHP 5101
(PVD GOLD)

PHP 5102
(MBL)

PHP 5103
(MAB)

PHP 5104
(MCF)

PHP 5105
(MSN)

Pull handle Pantheon

- Zamak Alloy
- 800MM



PHP 5111
(PVD GOLD)

PHP 5112
(MBL)

PHP 5113
(MAB)

PHP 5115
(MSN)

Pull handle Pantheon

- Zamak Alloy
- 1000MM



PHP 5121
(PVD GOLD)

PHP 5122
(MBL)

PHP 5123
(MAB)

PHP 5125
(MSN)

Pull handle Curvae

- Zamak Alloy
- 280MM



PHP 5141
(PVD GOLD)

PHP 5142
(MBL)

PHP 5143
(MAB)

PHP 5145
(MSN)

Pull handle Curvae

- Zamak Alloy
- 440MM



PHP 5151
(PVD GOLD)

PHP 5152
(MBL)

PHP 5153
(MAB)

PHP 5155
(MSN)

PULL HANDLE ZAMAK ALLOY

Pull handle Majestic

· Zamak Alloy
· 510MM

Available

PHP 5301 (R)

(MAB+GREEN CRYSTAL)

PHP 5302 (L)

(MAB+GREEN CRYSTAL)

PHP 5304



PHP 5303



PHP 5304

(LEFT, PVD GOLD+RED CRYSTAL)

PHP 5303

(RIGHT, PVD GOLD+RED CRYSTAL)

Pull handle Fiore

· Zamak Alloy
· 438MM



PHP 5131

(PVD GOLD)



PHP 5132

(MBL)



PHP 5133

(MAB)



PHP 5134

(MCF)

Pull handle Floare

· Zamak Alloy
· 490MM



PHP 5161

(PVD GOLD)



PHP 5162

(MBL)



PHP 5163

(MAB)

Pull handle Floare

· Zamak Alloy
· 670MM



PHP 5171

(PVD GOLD)



PHP 5172

(MBL)



PHP 5173

(MAB)

Pull handle Floare

· Zamak Alloy
· 870MM



PHP 5181
(PVD GOLD)



PHP 5182
(MBL)



PHP 5183
(MAB)

SMART
DIGITAL LOCK



1 2 3
4 5 6
7 8 9
* 0 #
← 0 🔒

PALOMA









SMART DIGITAL LOCK

Smart digital lock push/pull live camera

- palmprint, fingerprint, RFID card, PIN code
- mechanical key
- face recognition & live camera
- 5 admins & 235 users
- PALOMA Smart, TUYA Smart, Smart Life
- privacy deadbolt
- backset 60mm
- door thickness 40-120mm
- door frame min. 100mm
- backup port type-C
- rechargeable lithium battery
- aluminium alloy & polycarbonate

Available

DLP 6203DMB (DUMMY)



DLP 6203YMB
(MATTE BLACK)

Smart digital lock push/pull live camera

- palmprint, fingerprint, RFID card, PIN code
- mechanical key
- face recognition & live camera
- 5 admins & 235 users
- PALOMA Smart, TUYA Smart, Smart Life
- privacy deadbolt
- backset 60mm
- door thickness 40-120mm
- door frame min. 100mm
- backup port type-C
- rechargeable lithium battery
- aluminium alloy & polycarbonate

Available

DLP 6202DMB (DUMMY)



DLP 6202YMB
(MATTE BLACK)

Smart digital lock push/pull live camera

- palmprint, fingerprint (hidden), RFID card, PIN code
- mechanical key
- face recognition & live camera
- 5 admins & 235 users
- PALOMA Smart, TUYA Smart, Smart Life
- privacy deadbolt
- backset 60mm
- door thickness 40-120mm
- door frame min. 100mm
- backup port type-C
- rechargeable lithium battery
- aluminium alloy & glass

Available

DLP 6201DMB (DUMMY)



DLP 6201YMB
(MATTE BLACK)

Smart digital lock push/pull video call

- fingerprint, RFID card, PIN code
- mechanical key
- face recognition & video call
- 10 admins & 240 users
- PALOMA Smart, TUYA Smart, Smart Life
- privacy deadbolt
- backset 60mm
- door thickness 40-100mm
- door frame min. 100mm
- backup port micro-USB
- rechargeable lithium battery
- aluminium alloy

Available

DLP 6001DGM (DUMMY)



DLP 6001GM
(GUNMETAL)

SMART DIGITAL LOCK

Smart digital lock push/pull video call

- fingerprint, RFID card, PIN code
- mechanical key
- face recognition & video call
- 10 admins & 240 users
- PALOMA Smart, TUYA Smart, Smart Life
- privacy deadbolt
- backset 60mm
- door thickness 40-100mm
- door frame min. 100mm
- backup port micro-USB
- rechargeable lithium battery
- aluminium alloy

Available

DLP 6000D (DUMMY)



DLP 6000
(GUNMETAL)

Smart digital lock with camera

- fingerprint, RFID card, PIN code
- mechanical key
- 9 admins & 291 users
- camera as door viewer
- PALOMA Smart, TUYA Smart, Smart Life
- privacy deadbolt
- backset 60mm
- door thickness 32-130mm
- door frame min. 105mm
- backup port micro-USB
- alkaline AA 4pcs or 8pcs
- tempered glass
- aluminium alloy



DLP 2138
(BLACK)

Smart digital lock

- fingerprint, RFID card, PIN code
- mechanical key
- 9 admins & 291 users
- PALOMA Smart, TUYA Smart, Smart Life
- privacy deadbolt
- backset 60mm
- door thickness 32-145mm
- door frame min. 105mm
- backup port micro-USB
- alkaline AA 4pcs or 8pcs
- tempered glass
- aluminium alloy

Available

DLP 2136 (NON APP. BLACK)



DLP 2131
(BLACK)

Smart digital lock

- fingerprint, RFID card, PIN code
- mechanical key
- 9 admins & 291 users
- PALOMA Smart, TUYA Smart, Smart Life
- privacy deadbolt
- backset 60mm
- door thickness 35-50mm
- door frame min. 105mm
- child proof inside handle
- backup port USB type-C
- alkaline AA 4pcs
- polycarbonate
- aluminium alloy



DLP 2101
(TITANIUM GREY)

SMART DIGITAL LOCK

Smart digital lock

- fingerprint, RFID card, PIN code
- mechanical key
- 9 admins & 291 users
- PALOMA Smart, TUYA Smart, Smart Life
- privacy toggle
- backset 45mm
- door thickness 35-75mm
- door frame min. 76mm
- backup port USB type-C
- alkaline AA 4pcs
- tempered glass
- aluminium alloy

Available

DLP 3131NMB (NO APP, MATTE BLACK)



DLP 3131YMB
(TUYA, MATTE BLACK)

Smart digital lock

- fingerprint, RFID card, PIN code
- mechanical key
- 9 admins & 291 users
- PALOMA Smart, TUYA Smart, Smart Life
- privacy toggle
- backset 50mm
- door thickness 33-60mm
- door frame min. 85mm
- backup port micro-USB
- alkaline AA 4pcs
- tempered glass
- aluminium alloy



DLP 3121
(MATTE BLACK)



DLP 3122
(SATIN NICKEL)

Smart digital lock slim

- fingerprint, RFID card, PIN code
- mechanical key
- 9 admins & 291 users
- PALOMA Smart, TUYA Smart, Smart Life
- backset 35mm
- door thickness 30-60mm
- door frame min. 56mm
- backup port micro-USB
- alkaline AAA 4pcs
- acrylic
- full SUS 304



DLP 5121
(MATTE BLACK)



DLP 5122
(SSS+PSS)

Smart digital lock slim

- fingerprint, RFID card, PIN code
- mechanical key
- 9 admins & 291 users
- PALOMA Smart, TUYA Smart, Smart Life
- backset 35mm
- door thickness 35-70mm
- door frame min. 55mm
- backup port type-C
- alkaline AA 4pcs
- tempered glass
- aluminium alloy



DLP 516B
(BLACK)



DLP 516S
(SILVER)

SMART DIGITAL LOCK

Smart digital lock deadbolt

- fingerprint, RFID card, PIN code
- mechanical key
- 9 admins & 291 users
- PALOMA Smart, TUYA Smart, Smart Life
- privacy button
- magnetic sensor
- backset adjustable 60/70mm
- door thickness 33-55mm
- door frame min.95mm
- backup port type-C
- alkaline AA 4pcs
- tempered glass
- aluminium alloy



DLP 4130YBK
(BLACK)



DLP 4130YSV
(SILVER)

Smart digital lock deadbolt

- fingerprint, RFID card, PIN code
- mechanical key
- 9 admins & 291 users
- PALOMA Smart, TUYA Smart, Smart Life
- privacy button
- magnetic sensor (optional)
- backset adjustable 60/70mm
- door thickness 31-50mm
- door frame min.95mm
- backup port micro-USB
- alkaline AA 4pcs
- acrylic
- aluminium alloy



DLP 4121
(MATTE BLACK)



DLP 4122
(SATIN NICKEL)

Smart digital lock deadbolt

- fingerprint, RFID card, PIN code
- mechanical key
- 9 admins & 291 users
- PALOMA Smart, TUYA Smart, Smart Life
- privacy button
- magnetic sensor (optional)
- backset adjustable 60/70mm
- door thickness 30-70mm
- door frame min.95mm
- backup port type-C
- alkaline AA 4pcs
- zamak alloy



DLP 415B
(BLACK)



DLP 415S
(SILVER)

Smart cylinder lock

- fingerprint and RFID card
- mechanical key
- admin & user
- TUYA bluetooth
- cylinder length adjustable 60/70mm
- backup port USB type-C
- battery CR123A (not included)
- cylinder full brass
- aluminium alloy



DLP 701B
(BLACK)



DLP 701S
(SILVER)

LEVER HANDLE
PLATE
BRASS





LEVER HANDLE PLATE EXCLUSIVE BRASS

Handle plate Vienna-L BB

· brass



HPP 7201
(SB)

HPP 7202
(MBL)

Handle plate Prague-L BB

· brass



HPP 7211
(SB)

HPP 7212
(MBL)

Handle plate Davinci BB

· 7 layers

· brass



HPP 101
(GP)

HPP 102
(BUB)

Handle plate Dragon BB

· 7 layers

· brass



HPP 103
(GP)

HPP 104
(BUB)

Handle plate Phoenix BB

· 7 layers

· brass

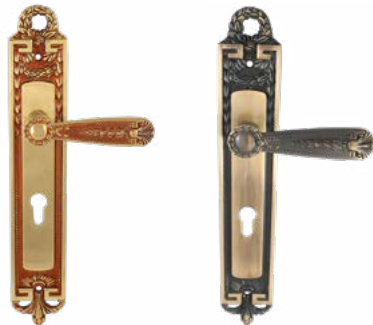

HPP 105
(AMB)

HPP 106
(MB)

Handle plate Rialto BB

· 7 layers

· brass



HPP 116
(GP)

HPP 117
(BUB)

Handle plate Canton BB

· 7 layers

· brass



HPP 107
(IA)

PALOMA[®]

HIGH QUALITY ARCHITECTURAL HARDWARE

LEVER HANDLE

PLATE

STAINLESS STEEL

SUS 304





LEVER HANDLE PLATE STAINLESS STEEL

Handle plate Alzante SS

· SUS 304



HPP 201
(SSS)

Handle plate Arpa

· SUS 304



HPP 202
(SSS)

Handle plate Attila SS

· SUS 304



HPP 203
(SSS)

Handle plate Pavone SS

· SUS 304



HPP 204
(SSS)

Handle plate Ceko SS

· SUS 304



HPP 251
(SSS)

Handle plate Costa SS

· SUS 304



HPP 252
(SSS)

Handle plate Nice SS

· SUS 304



HPP 253
(SSS)

LEVER HANDLE
PLATE
ZAMAK ALLOY



LEVER HANDLE PLATE ZAMAK

Handle plate Damasco ZZ

- 7 layers
- zamak alloy



HPP 514
(GP)



HPP 515
(SN)



HPP 516
(CF)



HPP 517
(MAB)

Handle plate Ankara ZZ

- 7 layers
- zamak alloy



HPP 527
(GP)



HPP 528
(SN)



HPP 529
(MAB)

Handle plate Paris ZZ

- 7 layers
- zamak alloy



HPP 523
(CF)



HPP 524
(MAB)

Handle plate Praha ZZ

- zamak alloy



HPP 531
(CF)



HPP 532
(MAB)

Handle plate Pyramid ZZ

- 7 layers
- zamak alloy



HPP 501
(GB)

LEVER HANDLE PLATE ZAMAK

Handle plate Alais ZZ

· zamak alloy



HPP 553
(SG+GP)

HPP 554
(SN+NP)

Handle plate Havana ZZ

· zamak alloy



HPP 555
(SG+GP)

HPP 556
(SN+NP)

Handle plate Canberra ZZ

· zamak alloy



HPP 559
(SG+GP)

HPP 560
(SN+NP)

HPP 562
(MAB)

Handle plate Wina ZZ

· zamak alloy



HPP 563
(SG+GP)

HPP 564
(SN+NP)

HPP 566
(MAB)

Handle plate N-Canberra ZZ

· zamak alloy



HPP 573
(SG+GP)

HPP 574
(SN+NP)

HPP 576
(MAB)

Handle plate Berlino ZZ

· zamak alloy



HPP 567
(SG+GP)

HPP 568
(SN+NP)

Handle plate Hope SQ ZZ

· zamak alloy



HPP 572
(SN+NP)

Handle plate Calvin SQ ZZ

· zamak alloy



HPP 570
(SN+NP)

LEVER HANDLE PLATE ZAMAK + ALUMINIUM

Handle plate Dakar ZA

· zamak alloy + aluminium



HPP 651
(SG+GP)



HPP 652
(SN+NP)

Handle plate Bogota ZA

· zamak alloy + aluminium



HPP 653
(SG+GP)



HPP 654
(SN+NP)

Handle plate Havana SQ ZA

· zamak alloy + aluminium

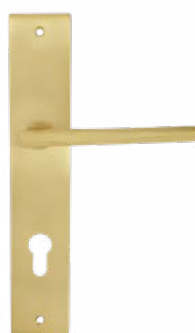

HPP 657
(SG+GP)



HPP 658
(SN+NP)

LEVER HANDLE PLATE IRON + ALUMINIUM

Handle plate Tirana IA

· iron + aluminium



HPP 710
(SN+NP)

Handle plate Andora IA

· iron + aluminium



HPP 712
(SN+NP)

Handle plate Luanda IA

· iron + aluminium



HPP 715
(SN+NP)

Handle plate Dublin IA

· iron + aluminium



HPP 717
(SN+NP)

Handle plate Tokyo IA

· iron + aluminium



HPP 724
(SN+NP)

HANDLE
ENTRANCE
BRASS



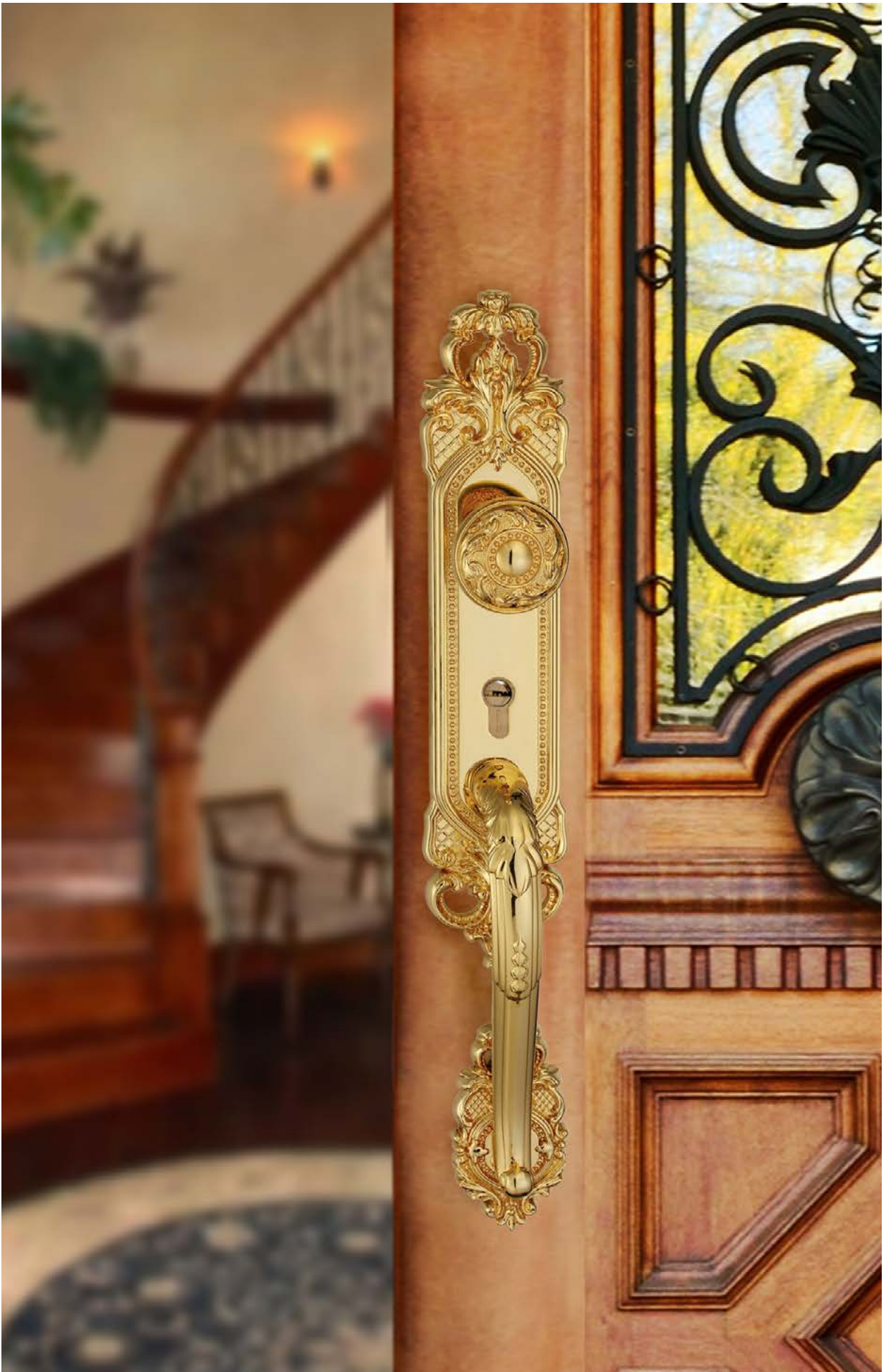

HANDLE ENTRANCE BRASS

Handle entrance Rialto BB

· brass



HEP 116
(GP)



HEP 117
(BUB)

LEVER HANDLE
ROSES
BRASS



LEVER HANDLE ROSES BRASS

Handle roses Vienna BB

· brass



HRP 7101
(SB)

HRP 7102
(MBL)

Handle roses Prague BB

· brass



HRP 7111
(SB)

HRP 7112
(MBL)

Handle roses Munich BB

· brass



HRP 7121
(SB)

HRP 7122
(MBL)

HRP 7123
(GUNMETAL)

HRP 7125
(SN)

Handle roses Salzburg BB

· brass



HRP 7131
(SB)

HRP 7132
(MBL)

HRP 7133
(GUNMETAL)

HRP 7134
(SC)

HRP 7135
(SN)

HRP 7137
(AB)

Handle roses Lyon BB

· brass

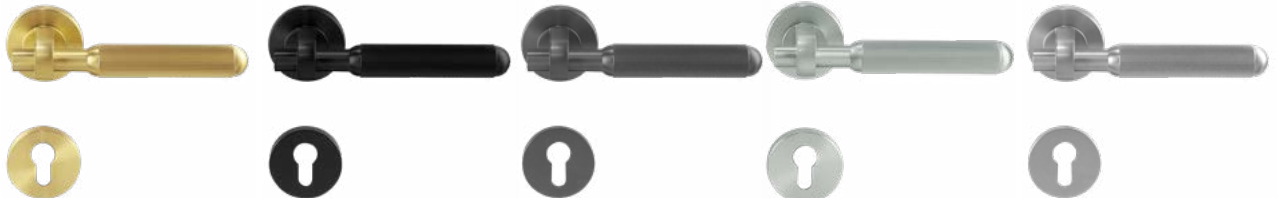

HRP 7141
(SB)

HRP 7142
(MBL)

HRP 7143
(GUNMETAL)

HRP 7144
(SC)

HRP 7145
(SN)

Handle roses Sofia BB

· brass

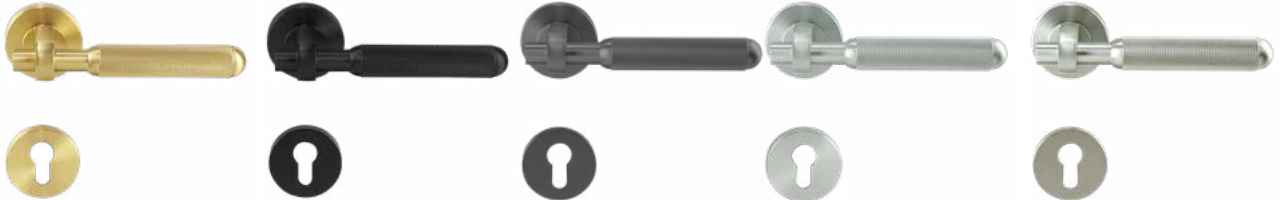

HRP 7151
(SB)

HRP 7152
(MBL)

HRP 7153
(GUNMETAL)

HRP 7154
(SC)

HRP 7155
(SN)

Handle roses Geneva BB

· brass

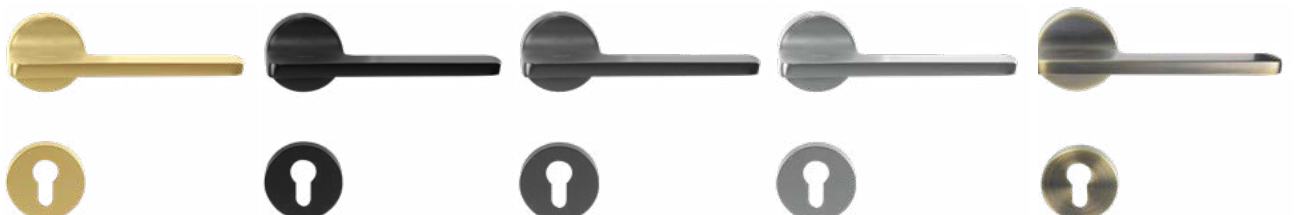

HRP 7161
(SB)

HRP 7162
(MBL)

HRP 7163
(GUNMETAL)

HRP 7165
(SN)

HRP 7167
(AB)

LEVER HANDLE ROSES BRASS

Handle roses Milan BB

· brass



HRP 7173
(GUNMETAL)

HRP 7176
(RAB)

Handle roses Hamberg BB

· brass



HRP 7182
(MBL)

HRP 7183
(GUNMETAL)

HRP 7184
(SC)

HRP 7185
(SN)

Handle roses Venice BB

· brass



HRP 7191
(SB)

HRP 7192
(MBL)

HRP 7193
(GUNMETAL)

HRP 7194
(SC)

HRP 7195
(SN)

HRP 7197
(AB)

Handle roses Hagen BB

· brass



HRP 7201
(SB)

HRP 7202
(MBL)

HRP 7203
(GUNMETAL)

HRP 7204
(SC)

HRP 7205
(SN)

HRP 7206
(RAB)

Handle roses Bern SS

· brass



HRP 7211
(SB)

HRP 7212
(MBL)

HRP 7213
(GUNMETAL)

HRP 7214
(SC)

HRP 7215
(SN)

HRP 7217
(AB)

LEVER HANDLE ROSES BRASS

Handle roses Leuven BB

· brass



HRP 7221
(SB)



HRP 7222
(MBL)



HRP 7223
(GUNMETAL)



HRP 7225
(SN)



HRP 7226
(RAB)

Handle roses Linz BB

· brass



HRP 7231
(SB)



HRP 7232
(MBL)



HRP 7233
(GUNMETAL)



HRP 7235
(SN)



LEVER HANDLE ROSES BRASS

Handle roses Zurich SQ BB

· brass



HRP 7242
(MBL)



HRP 7243
(GUNMETAL)



HRP 7244
(SC)



HRP 7245
(SN)

Handle roses Dresden SQ BB

· brass



HRP 7251
(SB)



HRP 7252
(MBL)



HRP 7255
(SN)



LEVER HANDLE
ROSES
7 LAYERS BRASS





LEVER HANDLE ROSES 7 LAYERS BRASS

Handle roses Davinci BB

- 7 layers
- brass



HRP 101
(GP)



HRP 102
(BUB)

Handle roses Dragon BB

- 7 layers
- brass



HRP 103
(GP)



HRP 104
(BUB)

Handle roses Canton BB

- 7 layers
- brass



HRP 107
(IA)

Handle roses Rialto BB

- 7 layers
- brass



HRP 116
(GP)



HRP 117
(BUB)

LEVER HANDLE
SOLID ROSES
STAINLESS
SUS 304





LEVER HANDLE SOLID ROSES STAINLESS STEEL

Handle roses LHS Klose SS

- full solid stainless steel
- SUS 304



HRP 201
(SSS)

Handle roses LHS Cana SS

- full solid stainless steel
- SUS 304



HRP 202
(SSS)

Handle roses LHS Parigi SS

- full solid stainless steel
- SUS 304



HRP 203
(SSS)

Handle roses LHS Ascot SQ SS

- full solid stainless steel
- SUS 304



HRP 210
(SSS)

Handle roses LHS Bravo SS

- full solid stainless steel
- SUS 304



HRP 215
(SSS)



HRP 218
(PVD GOLD)

Handle roses LHS Wigan SS

- full solid stainless steel
- SUS 304



HRP 251
(SSS)

Handle roses LHS Mosca SS

- full solid stainless steel
- SUS 304



HRP 252
(SSS+PSS)

Handle roses LHS Laguna SS

- full solid stainless steel
- SUS 304



HRP 253
(SSS)

Handle roses LHS Ruben SS

- full solid stainless steel
- SUS 304



HRP 254
(SSS)

Handle roses LHS Salvio SS

- full solid stainless steel
- SUS 304



HRP 255
(SSS)

LEVER HANDLE
TUBE ROSES
STAINLESS





LEVER HANDLE TUBE ROSES STAINLESS STEEL SUS 304

Handle roses LHT Porto SQ SS

· SUS 304



HRP 3101
(SSS)

Handle roses LHT Bergen SS

· SUS 304



HRP 3111
(SSS)

Handle roses LHT York SS

· SUS 304



HRP 3121
(SSS)

Handle roses LHT Luzern SS

· SUS 304



HRP 3131
(SSS)

Handle roses LHT Livorno SS

· SUS 304



HRP 3141
(SSS)

Handle roses LHT Reine SS

· SUS 304



HRP 3151
(SSS)

Handle roses LHT Obidos SS

· SUS 304



HRP 3161
(SSS)

Handle roses LHT Branko

19mm SS-304

· SUS 304



HRP 3211
(SSS)

Handle roses LHT Milos

19mm SS-304

· SUS 304



HRP 3221
(SSS)

Handle roses LHT Neven

19mm SS-304

· SUS 304



HRP 3231
(SSS)

Handle roses LHT Zlatan

19mm SS-304

· SUS 304



HRP 3241
(SSS)

Handle roses LHT Zoran

19mm SS-304

· SUS 304



HRP 3251
(SSS)

LEVER HANDLE TUBE ROSES STAINLESS STEEL SUS 304

Handle roses LHT Oliva SS

· SUS 304



HRP 301
(SSS+PSS)

HRP 335
(MBL)

Handle roses LHT Lazio SQ SS

· SUS 304



HRP 302
(SSS)

HRP 303
(SSS+PSS)

Handle roses LHT Barca SS

· SUS 304



HRP 304
(SSS)

Handle roses LHT Barca OV SS

· SUS 304



HRP 305
(SSS)

Handle roses LHT Ruben SQ SS

· SUS 304



HRP 306
(SSS)

HRP 333
(MBL)

Handle roses LHT Ruben OV SS

· SUS 304



HRP 307
(SSS)

HRP 385
(MBL)

Handle roses LHT Vidic SS

· SUS 304



HRP 308
(SSS)

Handle roses LHT Pablo SS

· SUS 304



HRP 309
(SSS)

HRP 330
(MBL)

Handle roses LHT Pablo OV SS

· SUS 304



HRP 310
(SSS)

Handle roses LHT Varane SS

· SUS 304



HRP 311
(SSS)

Handle roses LHT Felipe SS

· SUS 304



HRP 313
(SSS)

Handle roses LHT Vania SS

· SUS 304



HRP 314
(SSS)

HRP 329
(MBL)

LEVER HANDLE TUBE ROSES STAINLESS STEEL SUS 304

Handle roses LHT Alonso SS

· SUS 304



HRP 315
(SSS)

Handle roses LHT Calvo SQ SS

· SUS 304



HRP 316
(SSS)

HRP 331
(MBL)

Handle roses LHT Tomer SS

· SUS 304



HRP 317
(SSS)

HRP 328
(MBL)

Handle roses LHT Fontas SS

· SUS 304



HRP 318
(SSS+PSS)

Handle roses LHT Marcano SQ SS

· SUS 304



HRP 319
(SSS)

HRP 320
(SSS+PSS)

Handle roses LHT Xisco SQ SS

· SUS 304



HRP 321
(SSS)

HRP 322
(SSS+PSS)

Handle roses LHT Gerardo SQ SS

· SUS 304



HRP 323
(SSS)

HRP 332
(MBL)

Handle roses LHT Gerardo LSQ SS

· SUS 304



HRP 324
(SSS)

Handle roses LHT Gerardo SS

· SUS 304



HRP 325
(SSS)

Handle roses LHT Pablo-22MM SS

· SUS 304



HRP 326
(SSS)

Handle roses LHT N-Fontas SS

· SUS 304



HRP 327
(SSS+PSS)

Handle roses LHT Wigan SS

· SUS 304



HRP 351
(SSS)

HRP 334
(MBL)

LEVER HANDLE TUBE ROSES STAINLESS STEEL

Handle roses LHT Mosca SS

· SUS 304



HRP 352
(SSS+PSS)

Handle roses LHT Laguna SS

· SUS 304



HRP 353
(SSS)

Handle roses LHT Ruben SS

· SUS 304



HRP 354
(SSS)

HRP 382
(SG)

HRP 383
(MBL)

HRP 384
(GUNMETAL)

Handle roses LHT Salvio SS

· SUS 304



HRP 355
(SSS)

Handle roses LHT Branko 19MM SS

· stainless steel



HRP 401
(SSS)

Handle roses LHT Milos 19MM SS

· stainless steel



HRP 402
(SSS)

Handle roses LHT Neven 19MM SS

· stainless steel



HRP 403
(SSS)

Handle roses LHT Zlatan 19MM SS

· stainless steel



HRP 404
(SSS)

Handle roses LHT Zoran 19MM SS

· stainless steel



HRP 405
(SSS)

Handle roses LHT Plasil 19MM SS

· Stainless steel



HRP 406
(SSS)

Handle roses LHT Spirus SQ SS

· stainless steel

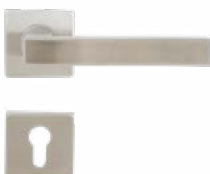

HRP 409
(SSS)

Handle roses LHT Noxia OV SS

· stainless steel



HRP 415
(SSS)

LEVER HANDLE TUBE ROSES STAINLESS STEEL

Handle roses LHT Branko 22MM SS

· stainless steel



HRP 417
(SSS)

Handle roses LHT Branko OV 19MM SS

· stainless steel



HRP 418
(SSS)

Handle roses LHT Zlatan 22MM SS

· stainless steel



HRP 419
(SSS)

Handle roses LHT Zlatan OV 19MM SS

· stainless steel



HRP 420
(SSS)

Handle roses LHT Legno 19MM SS

· stainless steel



HRP 421
(SSS)

Handle roses LHT Dolce SS

· stainless steel



HRP 422
(SSS)

Handle roses LHT Sike SS

· stainless steel



HRP 423
(SSS)

Handle roses LHT Fluke SS

· stainless steel



HRP 424
(SSS)

Handle roses LHT Blib SS

· stainless steel



HRP 425
(SSS)

Handle roses LHT Milos OV 19MM SS

· stainless steel



HRP 426
(SSS)

Handle roses LHT Plasil OV SS

· stainless steel



HRP 427
(SSS)

Handle roses LHT Noxia SS

· stainless steel



HRP 428
(SSS)

LEVER HANDLE
ROSES
ZAMAK ALLOY



LEVER HANDLE ROSES ZAMAK ALLOY

Handle roses Damasco ZZ

- 7 layers
- zamak alloy



HRP 514
(GP)



HRP 515
(SN)



HRP 516
(CF)



HRP 517
(MAB)

Handle roses N-Damasco ZZ

- 7 layers
- zamak alloy



HRP 518
(GP)



HRP 519
(SN)



HRP 520
(CF)



HRP 521
(MAB)

Handle roses Ankara ZZ

- zamak alloy



HRP 527
(GP)



HRP 528
(SN)



HRP 529
(MAB)

Handle roses Pyramid ZZ

- 7 layers
- zamak alloy

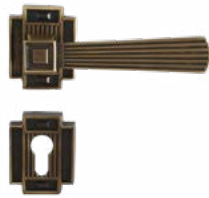

HRP 501
(GB)

Handle roses Panama ZZ

- zamak alloy



HRP 522
(MAB)

Handle roses Paris ZZ

- zamak alloy



HRP 523
(CF)

HRP 524
(MAB)

Handle roses Moscow ZZ

- zamak alloy



HRP 525
(CF)

HRP 526
(MAB)

Handle roses Hanoi ZZ

- zamak alloy



HRP 530
(MAB)

Handle roses Praha ZZ

- zamak alloy



HRP 531
(CF)

HRP 532
(MAB)

LEVER HANDLE ROSES ZAMAK ALLOY

Handle roses Canberra ZZ

· zamak alloy



HRP 559
(SG+GP)

HRP 560
(SN+NP)

HRP 562
(MAB)

HRP 5402
(MBL)

Handle roses Alais SQ ZZ

· zamak alloy



HRP 553
(SG+GP)

HRP 554
(SN+NP)

HRP 5401
(MBL)

Handle roses Wina ZZ

· zamak alloy



HRP 563
(SG+GP)

HRP 564
(SN+NP)

HRP 566
(MAB)

HRP 5403
(MBL)

Handle roses Hope SQ ZZ

· zamak alloy



HRP 572
(SN+NP)

HRP 5404
(MBL)

Handle roses Martin SQ ZZ

· zamak alloy



HRP 573
(CH)

HRP 5405
(MBL)

Handle roses Everton SQ ZZ

· zamak alloy



HRP 574
(CH)

HRP 5406
(MBL)

Handle roses Devlin SQ ZZ

· zamak alloy



HRP 575
(CH)

HRP 5407
(MBL)

Handle roses Castro ZZ

· zamak alloy



HRP 583
(CH)

HRP 5408
(MBL)

LEVER HANDLE ROSES ZAMAK ALLOY

Handle roses Preston SQ ZZ

· zamak alloy



HRP 569
(SN+NP)

Handle roses Calvin SQ ZZ

· zamak alloy



HRP 570
(SN+NP)

Handle roses Gera SQ ZZ

· zamak alloy



HRP 571
(SN+NP)

Handle roses Frazer SQ ZZ

· zamak alloy

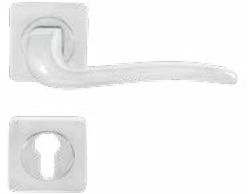

HRP 576
(CH)

Handle roses Nolan SQ ZZ

· zamak alloy



HRP 581
(SN+NP)

Handle roses Tamudo ZZ

· zamak alloy



HRP 582
(SN+NP)

Handle roses Baros ZZ

· zamak alloy



HRP 584
(SN+NP)

Handle roses Gabi ZZ

· zamak alloy



HRP 585
(SN+NP)

Handle roses Zavon ZZ

· zamak alloy



HRP 586
(SN+NP)

Handle roses Nadal ZZ

· zamak alloy



HRP 587
(SN+NP)

Handle roses Munich ZZ

· zamak alloy



HRP 5301
(SB)



HRP 5302
(MBL)



HRP 5303
(GUNMETAL)



HRP 5305
(SN)

LEVER HANDLE ROSES ZAMAK ALLOY

Handle roses Titan SQ ZZ

· zamak alloy



HRP 5101
(MSN)



HRP 5102
(MAB)



HRP 5103
(MBL)

Handle roses Voila ZZ

· zamak alloy



HRP 5232
(MBL)



HRP 5233
(GUNMETAL)



HRP 5235
(SATIN NICKEL)

Handle roses Malmo ZZ

· zamak alloy



HRP 5223
(MATTE BLACK)



HRP 5224
(GUNGREY)

Handle roses Leonor ZZ

· zamak alloy



HRP 5211
(GOLD PLATED)



HRP 5212
(MBL)



HRP 5213
(GUNMETAL)



HRP 5214
(WHITE)



HRP 5215
(SATIN NICKEL)



HRP 5216
(ANTIQUE COPPER)



HRP 5217
(ANTIQUE BRASS)



HRP 5218
(MATTE ROSE GOLD)



HRP 5219
(OLD IRON)



HRP 5220
(YELLOW BRONZE)



HRP 5221
(BLACK NICKEL)



HRP 5222
(DARK ROSE GOLD)

LEVER HANDLE
ROSES
ZAMAK ALLOY
+ ALUMINIUM





Handle roses Dakar ZA

· zamak alloy + aluminium



HRP 651
(SG+GP)



HRP 652
(SN+NP)

Handle roses Bogota ZA

· zamak alloy + aluminium



HRP 653
(SG+GP)



HRP 654
(SN+NP)

Handle roses Havana ZA

· zamak alloy + aluminium



HRP 655
(SG+GP)

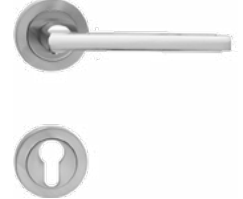

HRP 656
(SN)

Handle roses Havana SQ ZA

· zamak alloy + aluminium



HRP 658
(SN+NP)



HRP 6409
(MBL)

LEVER HANDLE

ROSES

SUPERALUM LITE



PALOMA

PALOMA





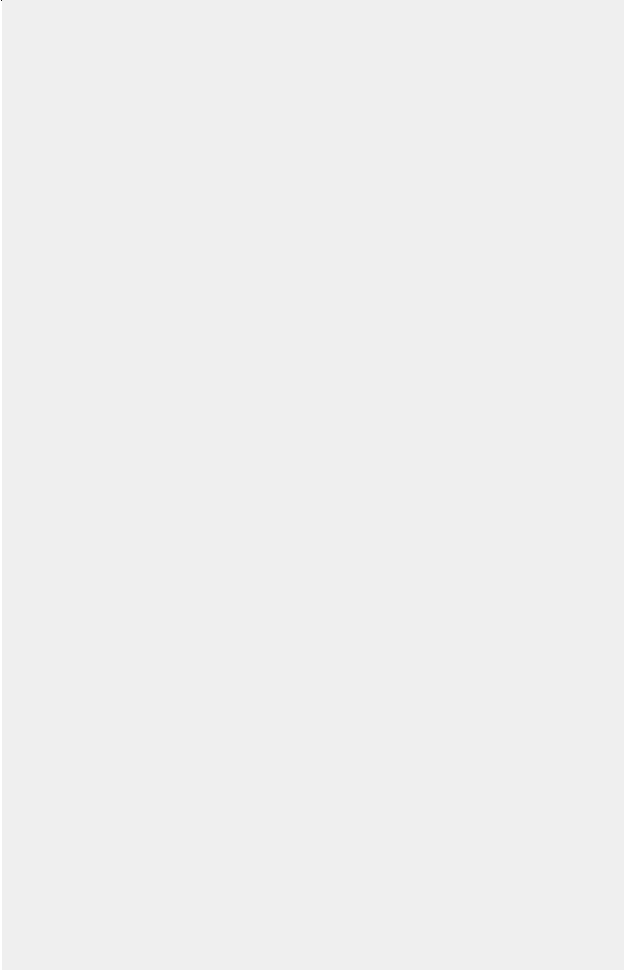
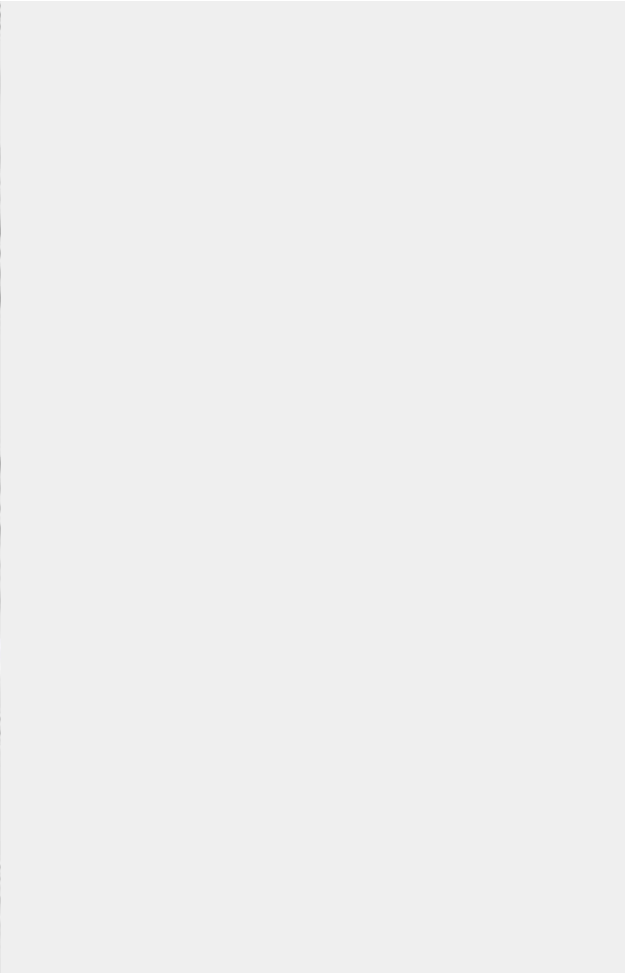

LEVER HANDLE ROSES ALUMINIUM

Handle roses Naples SQ AA

· aluminium



HRP 8101
(MBL)

HRP 8102
(BRONZE GREY)

HRP 8103
(NIGHT GREY)

HRP 8104
(SAND GOLD)

HRP 8105
(SATIN CHROME)

Handle roses Veneto SQ AA

· aluminium



HRP 8111
(MBL)

HRP 8112
(BRONZE GREY)

HRP 8113
(NIGHT GREY)

HRP 8114
(SAND GOLD)

HRP 8115
(SATIN CHROME)

Handle roses Madrid SQ AA

· aluminium



HRP 8121
(MBL)

HRP 8122
(BRONZE GREY)

HRP 8123
(NIGHT GREY)

HRP 8124
(SAND GOLD)

HRP 8125
(SATIN CHROME)

Handle roses Liscio AA

· aluminium



HRP 8131
(MBL)

HRP 8132
(BRONZE GREY)

HRP 8133
(NIGHT GREY)

HRP 8134
(SAND GOLD)

HRP 8135
(SATIN CHROME)

Handle roses Astana AA

· aluminium



HRP 8141
(MBL)

HRP 8142
(BRONZE GREY)

HRP 8143
(NIGHT GREY)

HRP 8144
(SAND GOLD)

HRP 8145
(SATIN CHROME)

Handle roses Dublin AA

· aluminium



HRP 8151
(MBL)

HRP 8152
(BRONZE GREY)

HRP 8153
(NIGHT GREY)

HRP 8154
(SAND GOLD)

HRP 8155
(SATIN CHROME)

LEVER HANDLE ROSES ALUMINIUM

Handle roses Gabriel AA

· aluminium



Handle roses Val AA

· aluminium



Handle roses Oscar AA

· aluminium



Handle roses Taylor AA

· aluminium



Handle roses Conrad SQ AA

· aluminium



Handle roses Vivienne AA

· aluminium



LEVER HANDLE ROSES ALUMINIUM

Handle roses Dante SQ AA

· aluminium



HRP 8221
(MBL)

HRP 8222
(BRONZE GREY)

HRP 8223
(NIGHT GREY)

HRP 8224
(SAND GOLD)

HRP 8225
(SATIN CHROME)

Handle roses Alex AA

· aluminium



HRP 8231
(MBL)

HRP 8232
(BRONZE GREY)

HRP 8233
(NIGHT GREY)

HRP 8234
(SAND GOLD)

HRP 8235
(SATIN CHROME)

Handle roses Exo AA

· for aluminium door

· aluminium



HRP 801
(WHITE)

HRP 802
(BLACK)

MAGNETIC DOOR LOCK SET





MAGNETIC DOOR LOCK SET

Magnetic door lock set Farmo K-CK ZA

· zamak alloy



MDP 5102
(MBL)



MDP 5103
(BRONZE GREY)

Magnetic door lock set rose Adria PT-NK ZA

· zamak alloy



MDP 5201
(MBL, RIGHT)



MDP 5202
(MBL, LEFT)



MDP 5203
(BRONZE GREY, RIGHT)



MDP 5204
(BRONZE GREY, LEFT)

Magnetic door lock set rose Rovigo SQ PT-NK ZA

· zamak alloy



MDP 5211
(MBL, RIGHT)



MDP 5212
(MBL, LEFT)



MDP 5213
(BRONZE GREY, RIGHT)



MDP 5214
(BRONZE GREY, LEFT)

Magnetic door lock set rose Rovigo OV PT-NK ZA

· zamak alloy



MDP 5221
(MBL, RIGHT)



MDP 5222
(MBL, LEFT)



MDP 5223
(BRONZE GREY, RIGHT)



MDP 5224
(BRONZE GREY, LEFT)

DOOR LOCK
KNOB



KNOB ROSES BRASS

Knob roses Palma BB

· brass



KRP 7101
(SB)



KRP 7102
(MBL)



KRP 7103
(GUNMETAL)



KRP 7104
(SC)



KRP 7105
(SN)

Knob roses Siena BB

· brass



KRP 7111
(SB)



KRP 7112
(MBL)



KRP 7113
(GUNMETAL)



KRP 7114
(SC)



KRP 7115
(SN)



KRP 7117
(AB)

FIXED KNOB

Fixed knob 200 - 1.0MM

· SUS 304



FKP 201
(SSS)



FKP 202
(MATTE BLACK)



FKP 203
(GUNMETAL)



FKP 204
(SG)

CYLINDRICAL KNOB

Cylindrical knob 9200 BK

· without key
· SUS 304



CKP 202
(SSS)

Cylindrical knob 9200 ET

· with key
· SUS 304



CKP 212
(SSS)

Cylindrical knob 8000 BK

· without key
· stainless steel



CKP 302
(SSS)

Cylindrical knob 8000 ET

· with key
· stainless steel



CKP 312
(SSS)

SLIDING DOOR LOCK





SLIDING DOOR

Sliding door lock set Argento SQ K-CK SS

- with key hole
- standard key
- SUS 304



SDP 3101
(SSS)



SDP 3102
(MATTE BLACK)



SDP 3103
(BRONZE GREY)

Sliding door lock set Argento SQ K-NK SS

- non key
- coin slot
- SUS 304



SDP 3201
(SSS)



SDP 3202
(MATTE BLACK)



SDP 3203
(BRONZE GREY)

Sliding door lock set Argento OV K-CK SS

- with key hole
- standard key
- SUS 304



SDP 3111
(SSS)



SDP 3112
(MATTE BLACK)



SDP 3113
(BRONZE GREY)

Sliding door lock set Argento OV K-NK SS

- non key
- coin slot
- SUS 304



SDP 3211
(SSS)



SDP 3212
(MATTE BLACK)



SDP 3213
(BRONZE GREY)

COMEN

Comen 101 (oval 12cm)

·SUS 316



CMP 102
(SSS)

Comen 102 (oval 15cm)

·SUS 316



CMP 105
(SSS)

Comen 104 (square 12cm)

·SUS 316



CMP 111
(SSS)

Comen 105 (oval 15cm)

·SUS 316



CMP 114
(SSS)

Comen 106 (square 18cm)

·SUS 316



CMP 117
(SSS)

Comen 207 (round 9cm)

·SUS 304



CMP 219
(SSS)

COMEN

Comen 201 (oval 12cm)

·SUS 304



CMP 201
(PVD)



CMP 202
(SSS)



CMP 203
(AB)



CMP 220
(MBL)



CMP 224
(PVD SG)



CMP 229
(GUNMETAL)

Comen 202 (oval 15cm)

·SUS 304



CMP 204
(PVD)



CMP 205
(SSS)



CMP 206
(AB)



CMP 223
(MBL)



CMP 225
(PVD SG)



CMP 230
(GUNMETAL)

Comen 204 (square 12cm)

·SUS 304



CMP 210
(PVD)



CMP 211
(SSS)



CMP 212
(AB)



CMP 226
(PVD SG)



CMP 231
(GUNMETAL)

Comen 205 (square 15cm)

·SUS 304



CMP 213
(PVD)



CMP 214
(SSS)



CMP 215
(AB)



CMP 221
(MBL)



CMP 227
(PVD SG)



CMP 232
(GUNMETAL)

Comen 206 (square 18cm)

·SUS 304



CMP 216
(PVD)



CMP 217
(SSS)



CMP 218
(AB)



CMP 222
(MBL)



CMP 228
(PVD SG)



CMP 233
(GUNMETAL)

HANDLE
FURNITURE



SIGN PLATE

Sign plate 003

- 30cm x 8cm
- SUS 304



SNP 201
(SSS)

Sign plate 003 + cylinder

- 30cm x 8cm
- SUS 304



SNP 202
(SSS)

Sign plate 004

- 30cm x 8cm
- SUS 304



SNP 211
(SSS)

Sign plate 004 + cylinder

- 30cm x 8cm
- SUS 304



SNP 212
(SSS)

FLUSH RING

Flush ring 202

- SUS 304



FRP 202
(SSS)

Flush ring 203

- SUS 304



FRP 203
(MBL)

Flush ring 204

- SUS 304



FRP 204
(AB)

Flush ring 205

- SUS 304



FRP 205
(PVD GOLD)

FURNITURE PULL

Furniture pull Castle

- 90mm
- brass



FPP 601 (PB) FPP 605 (SN) FPP 613 (AB) FPP 617 (MBL)

Furniture pull Castle

- 125mm
- brass



FPP 602 (PB) FPP 606 (SN) FPP 614 (AB) FPP 618 (MBL)

Furniture pull Castle

- 170mm
- brass



FPP 603 (PB) FPP 607 (SN) FPP 615 (AB) FPP 619 (MBL)

Furniture pull Castle

- 195mm
- brass



FPP 604 (PB) FPP 608 (SN) FPP 616 (AB) FPP 620 (MBL)

Furniture pull Ghibli

- 145mm
- zamak alloy



FPP 701 (GP) FPP 702 (SN) FPP 704 (AB)

Furniture pull Libra

- spring system
- SUS 304



FPP 301 (PVD) FPP 302 (SSS) FPP 303 (RAB) FPP 304 (MBL)

LATCH FOR SHAFT

Latch for shaft 201

- SUS 304



LSP 201 (SSS)

ESCUTCHEON

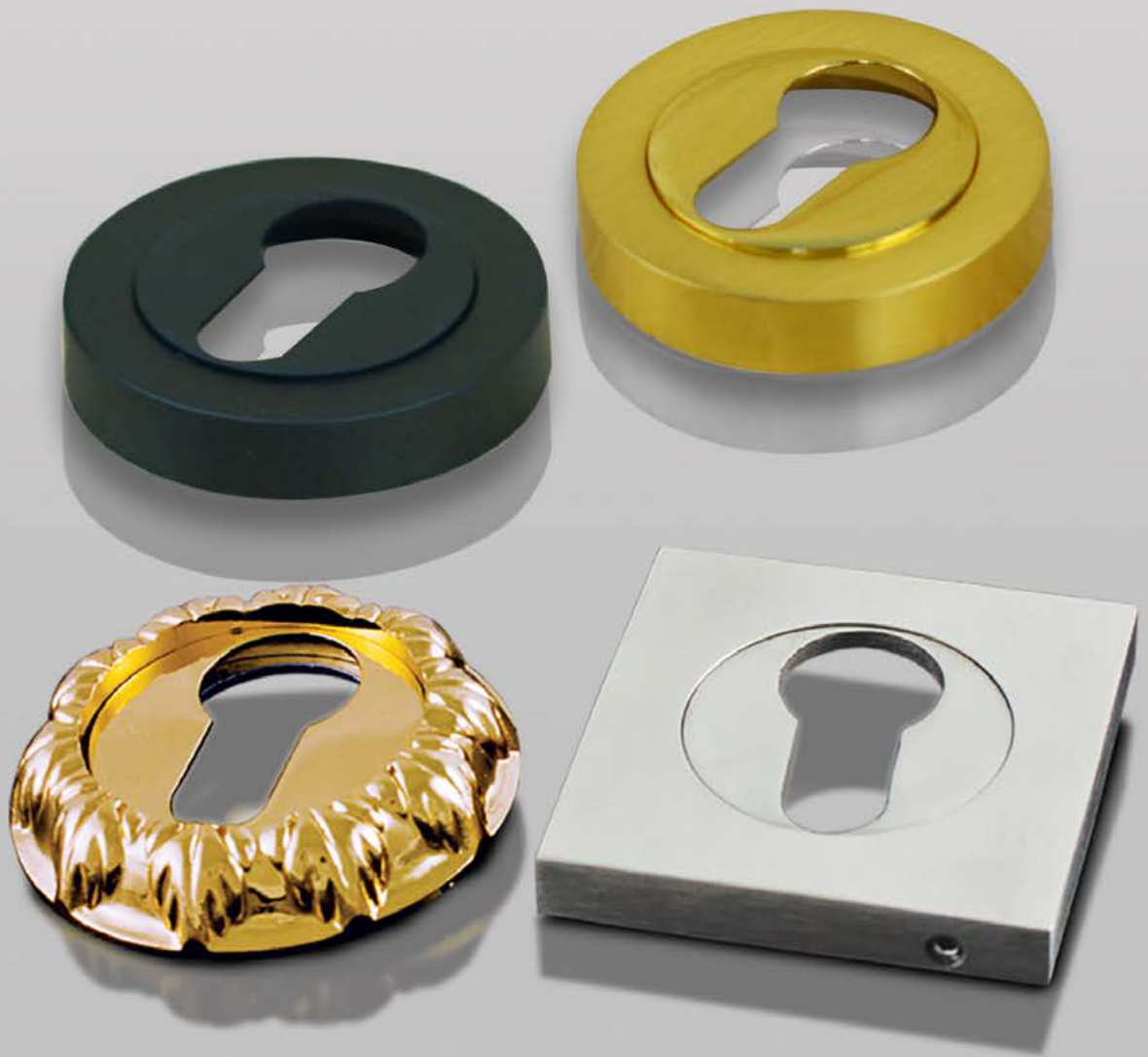

ESCUTCHEON BRASS

Escutcheon exclusive

- made in Italy
- brass



ECP 901
(GS)



ECP 902
(GP)



ECP 903
(OV)



ECP 904
(YB)



ECP 905
(GR)



ECP 906
(SP)

Escutcheon premium 001

- brass



ECP 501
(GP)



ECP 502
(BUB)

Escutcheon premium 600

- brass



ECP 6001
(24K GOLD)



ECP 6002
(RAB)

Escutcheon premium 620

- brass



ECP 6201
(SB)



ECP 6202
(MBL)



ECP 6203
(GUNMETAL)



ECP 6205
(SN)



ECP 6206
(RAB)



ECP 6207
(AB)



ECP 6208
(AC)



ECP 6209
(GP)

Escutcheon deluxe 001

- brass



ECP 301
(GP)



ECP 302
(SN)



ECP 303
(SN+CH)



ECP 304
(AB)



ECP 305
(SB)

ESCUTCHEON STAINLESS STEEL SUS 304

Escutcheon premium 006 (square)

·SUS 304



ECP 531
(SSS)

Escutcheon premium 007

·SUS 304



ECP 541
(SSS)

Escutcheon deluxe 004 (small)

·SUS 304



ECP 331
(SSS)



ECP 333
(MBL)



ECP 334
(AB)



ECP 335
(PVD GOLD)



ECP 336
(PVD SG)



ECP 337
(GUNMETAL)

Escutcheon deluxe 007 (square)

·SUS 304



ECP 361
(SSS)



ECP 363
(MBL)



ECP 364
(AB)



ECP 365
(PVD GOLD)



ECP 366
(PVD SG)



ECP 367
(GUNMETAL)

Escutcheon deluxe 006 (round)

·SUS 304



ECP 351
(SSS)



ECP 353
(MBL)

Escutcheon deluxe 005 (oval)

·SUS 304



ECP 341
(SSS)



ECP 343
(MBL)

Escutcheon deluxe 008 (round)

·SUS 304



ECP 371
(SSS)



ECP 372
(SSS+PSS)

ESCUTCHEON ZAMAK ALLOY

Escutcheon prestige 510

· zamak alloy



ECP 5101
(SB)



ECP 5102
(MBL)



ECP 5103
(GUNMETAL)



ECP 5105
(SN)



ECP 5106
(RAB)



ECP 5107
(AB)



ECP 5108
(AC)



ECP 5109
(GP)

Escutcheon superior 003

· zamak alloy



ECP 223
(MAB)

Escutcheon standard 001

· zamak alloy



ECP 101
(GP)



ECP 102
(SN)

Escutcheon superior 002

· zamak alloy



ECP 251
(SN)



ECP 252
(SN+NP)



ECP 253
(MBL)

ESCUTCHEON ZAMAK ALLOY

Escutcheon superior 005 (square)

· zamak alloy



ECP 241
(BSN)

ECP 242
(MBN)

ECP 243
(MAC)

ECP 244
(MAB)

Escutcheon superior 004 (rectangle)

· zamak alloy



ECP 231
(BSN)

ECP 232
(MBN)

ECP 233
(MAC)

ECP 234
(MAB)

Escutcheon superior 001 (square)

· zamak alloy



ECP 201
(SN)

ECP 202
(SN+NP)

ECP 203
(MBL)

MORTISE LOCK

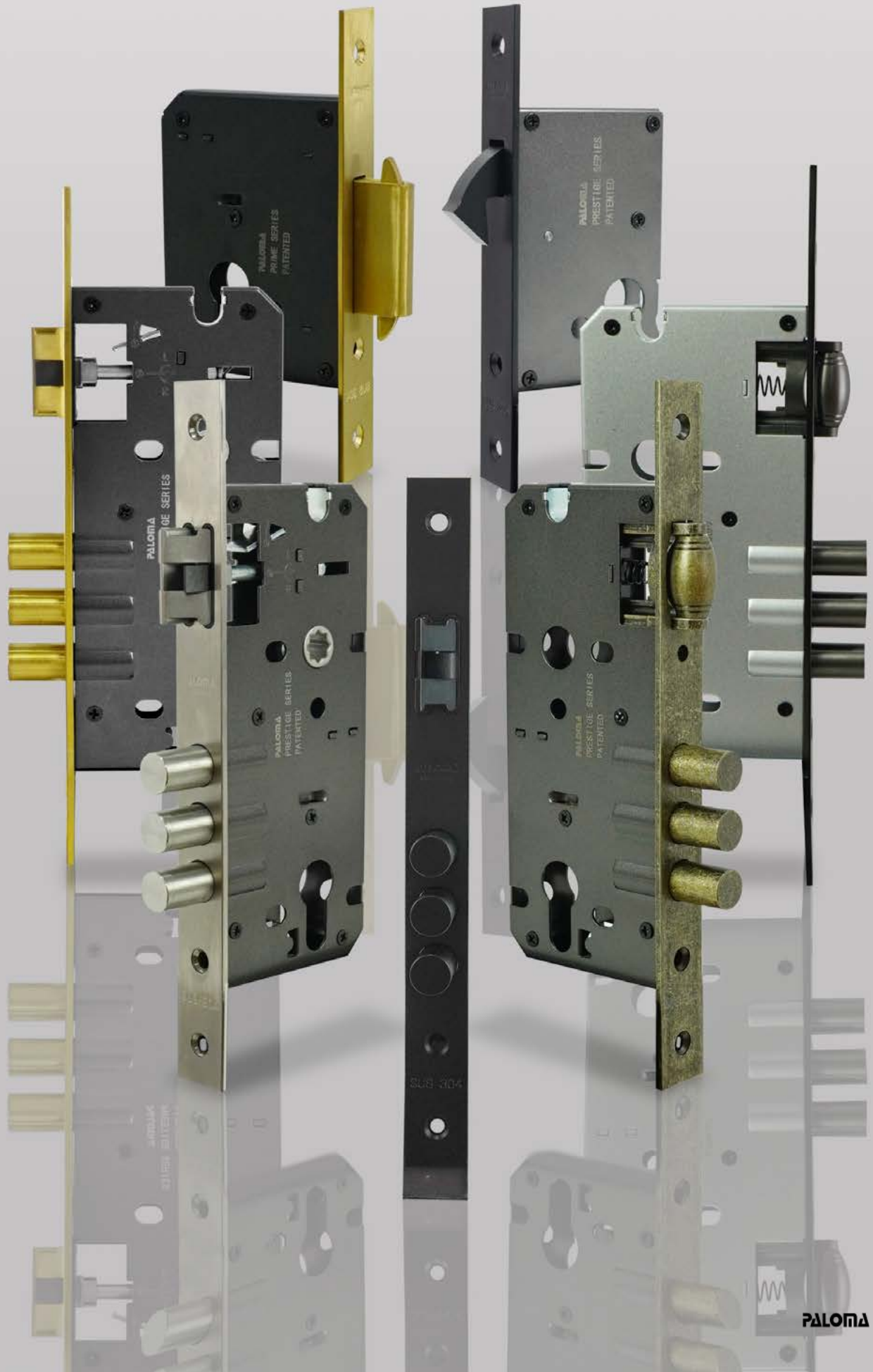

Mortise lock exclusive swing

- made in Italy
- backset 60mm
- SUS 304 (SSS & MBL)
- euro brass (PB & AB)



Mortise lock exclusive swing

- made in Italy
- backset 50mm
- SUS 304 (SSS & MBL)
- euro brass (PB & AB)



Mortise lock exclusive swing

- made in Italy
- backset 60mm
- SUS 304 (SSS & SB)
- euro brass (MBL)

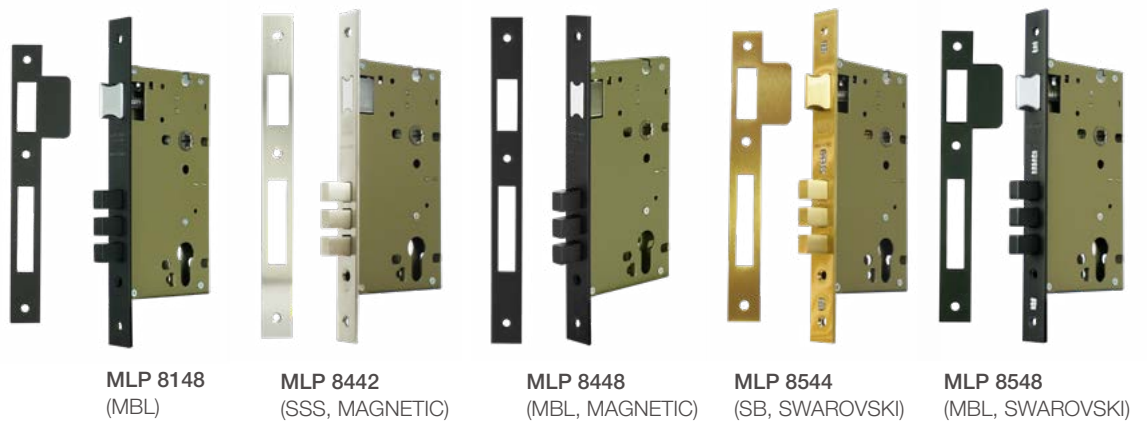

Mortise lock exclusive swing

- made in Italy
- backset 50mm
- SUS 304 (SSS & SB)
- euro brass (MBL)



MORTISE LOCK SWING

Mortise lock premium swing

- backset 70mm
- SUS 316

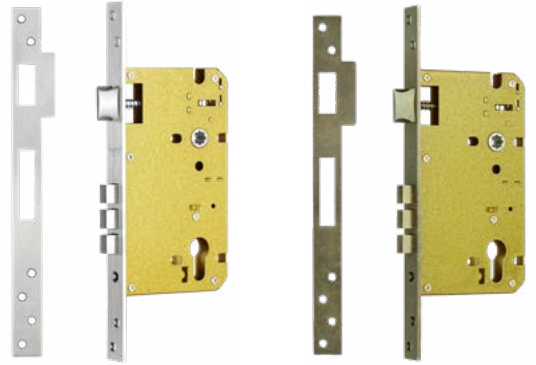

MLP 752
(SSS)

MLP 753
(RAB)

Mortise lock premium swing

- backset 60mm
- SUS 316



MLP 742
(SSS)

Mortise lock premium swing

- backset 50mm
- SUS 316



MLP 732
(SSS)

Mortise lock signature swing

- backset 60mm
- SUS 316



MLP 4142
(SSS)

MLP 4143
(RAB)

MLP 4148
(MBL)

MLP 4149
(GUNMETAL)

Mortise lock signature swing

- backset 50mm
- SUS 316



MLP 4132
(SSS)

MLP 4133
(RAB)

MLP 4138
(MBL)

MLP 4139
(GUNMETAL)

MORTISE LOCK SWING

Mortise lock prestige swing

- backset 60mm
- SUS 304



Mortise lock prestige swing

- backset 50mm
- SUS 304



Mortise lock prestige swing

- backset 30mm
- SUS 304



Mortise lock deluxe swing

- backset 60mm
- SUS 304

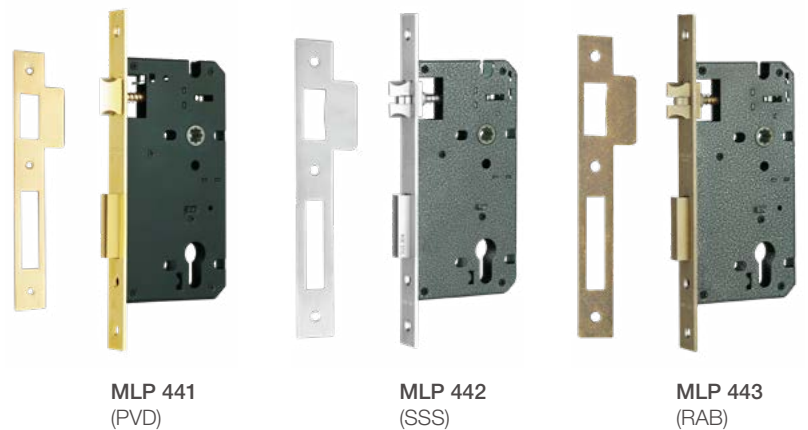

MORTISE LOCK SWING

Mortise lock deluxe swing

- backset 50mm
- SUS 304



MLP 431
(PVD)

MLP 432
(SSS)

MLP 433
(RAB)

Mortise lock deluxe swing

- backset 60mm
- metal door recommended
- SUS 304

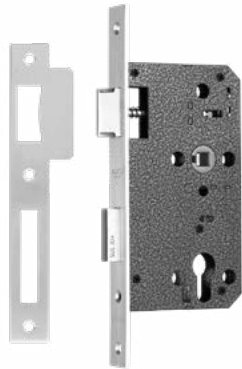

MLP 482
(SSS)

Mortise lock deluxe swing

- backset 60mm
- panic door recommended
- SUS 304



MLP 492
(SSS)

Mortise lock deluxe swing

- backset 30mm
- SUS 304



MLP 412
(SSS)

Mortise lock prime swing

- backset 30mm
- SUS 304



MLP 2112
(SSS)

MLP 2118
(MBL)

Mortise lock prime swing

- backset 60mm
- SUS 304



Available
MLP 2147 (AB)

MLP 2141
(PVD SG)

MLP 2142
(SSS)

MLP 2143
(RAB)

MLP 2148
(MBL)

MLP 2149
(GUNMETAL)

MORTISE LOCK SWING

Mortise lock prime swing

- backset 50mm
- SUS 304



Available
MLP 2137 (AB)

MLP 2131
(PVD SG)

MLP 2132
(SSS)

MLP 2133
(RAB)

MLP 2138
(MBL)

MLP 2139
(GUNMETAL)

Mortise lock prime swing

- backset 40mm
- SUS 304

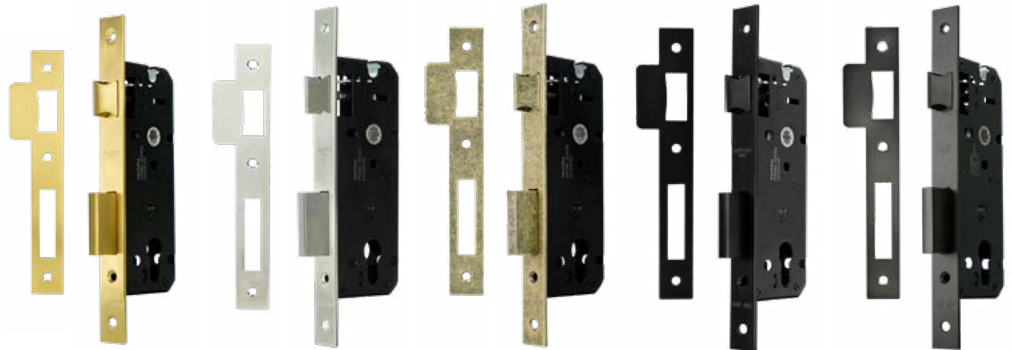

Available
MLP 2127 (AB)

MLP 2121
(PVD SG)

MLP 2122
(SSS)

MLP 2123
(RAB)

MLP 2128
(MBL)

MLP 2129
(GUNMETAL)

Mortise lock superior swing

- backset 60mm
- SUS 304

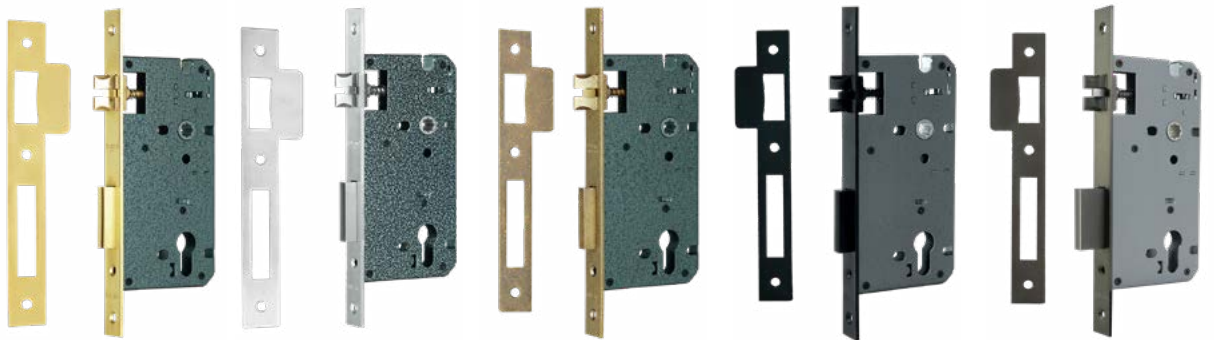

MLP 341
(PVD)

MLP 342
(SSS)

MLP 343
(RAB)

MLP 348
(MBL)

MLP 349
(GUNMETAL)

Mortise lock superior swing

- backset 50mm
- SUS 304



MLP 331
(PVD)

MLP 332
(SSS)

MLP 333
(RAB)

MLP 338
(MBL)

MLP 339
(GUNMETAL)

MORTISE LOCK SWING

Mortise lock superior swing

- backset 40mm
- SUS 304

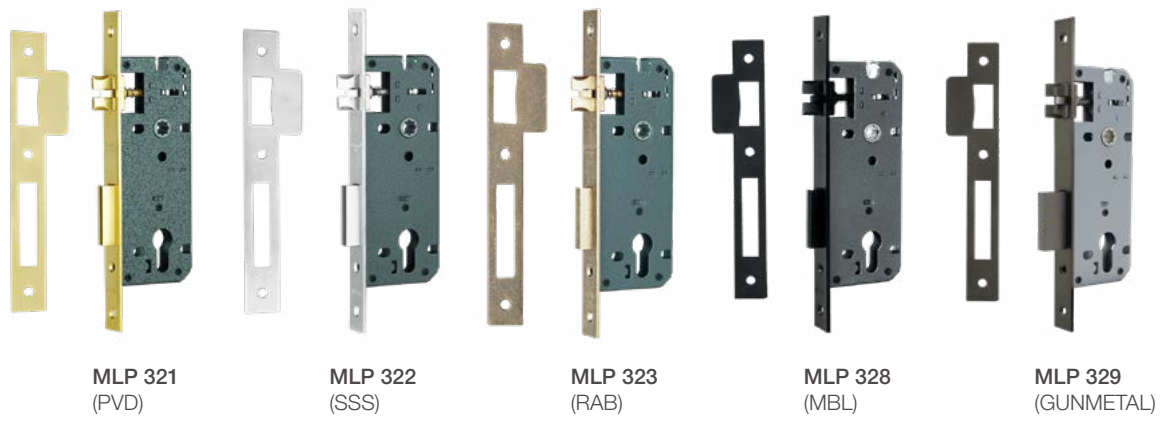

Mortise lock lite swing

- backset 50mm
- SUS 304



Mortise lock lite swing

- backset 40mm
- SUS 304



Mortise lock standard swing

- stainless steel



Mortise lock standard swing

- backset 30mm
- stainless steel



Mortise lock exclusive roller

- made in Italy
- backset 60mm
- euro brass



Mortise lock exclusive roller

- made in Italy
- backset 50mm
- euro brass



Mortise lock premium roller

- backset 70mm
- SUS 316



Mortise lock premium roller

- backset 50mm
- SUS 316



Mortise lock premium roller

- backset 60mm
- SUS 316



Mortise lock prestige roller

- backset 30mm
- SUS 304



MORTISE LOCK ROLLER

Mortise lock signature roller

- backset 60mm
- SUS 316

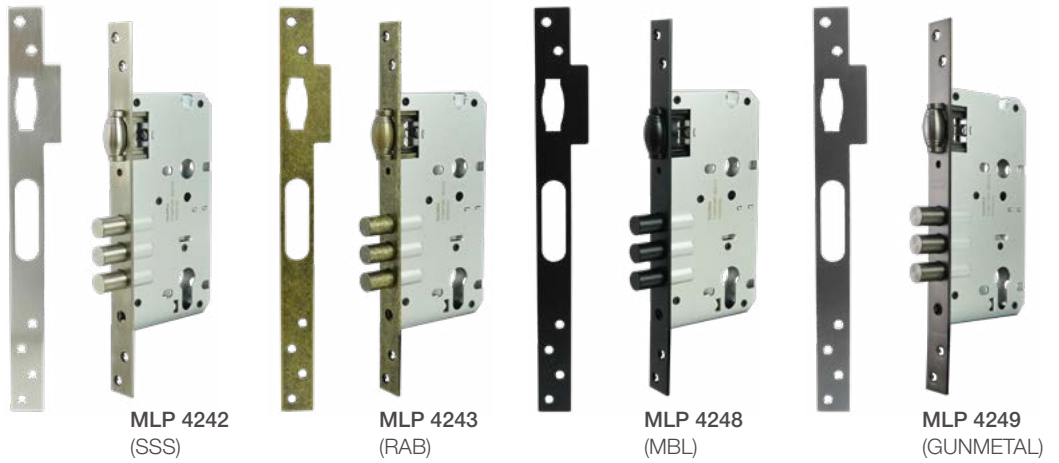

Mortise lock signature roller

- backset 50mm
- SUS 316

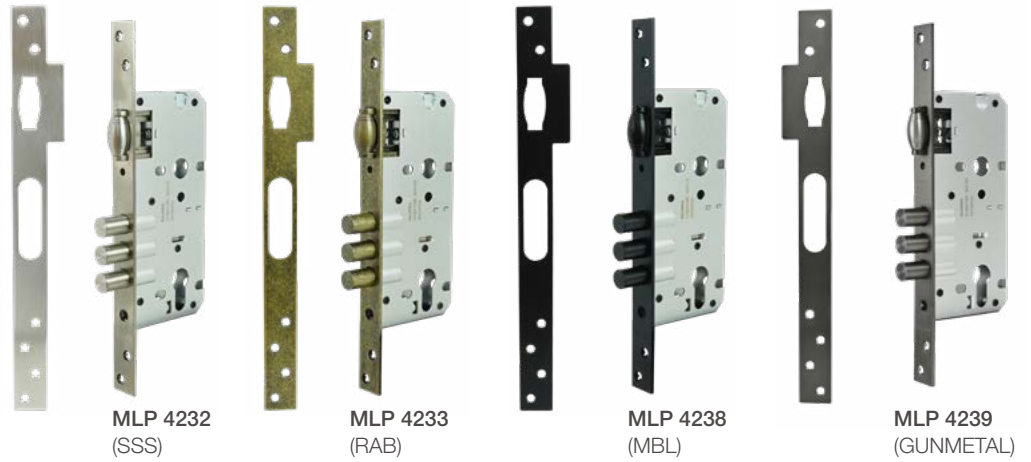

Mortise lock prestige roller

- backset 60mm
- SUS 304



Mortise lock prestige roller

- backset 50mm
- SUS 304



MORTISE LOCK ROLLER

Mortise lock deluxe roller 60mm

- backset 60mm
- SUS 304



MLP 541
(PVD)



MLP 542
(SSS)

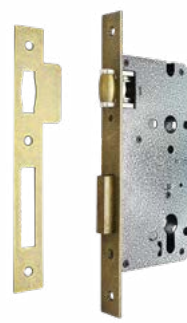

MLP 543
(RAB)



MLP 548
(MBL)

Mortise lock deluxe roller 50mm

- backset 50mm
- SUS 304



MLP 531
(PVD)



MLP 532
(SSS)



MLP 533
(RAB)



MLP 538
(MBL)

Mortise lock deluxe roller

- SUS 304



MLP 528
(MBL, 40MM)



MLP 512
(SSS, 30MM)

Mortise lock prime roller

- backset 30mm
- SUS 304



MLP 2212
(SSS)

Mortise lock lite roller

- backset 40mm
- SUS 304



MLP 1222
(SSS)



MLP 1228
(MBL)



MLP 1229
(GUNMETAL)

Available
MLP 1223 (RAB)

MORTISE LOCK ROLLER

Mortise lock lite roller

- backset 50mm
- SUS 304



Available
MLP 1233 (RAB)

MLP 1232
(SSS)

MLP 1238
(MBL)

MLP 1239
(GUNMETAL)

Mortise lock prime roller

- backset 60mm
- SUS 304



Available
MLP 2247 (AB)

MLP 2241
(PVD SG)

MLP 2242
(SSS)

MLP 2243
(RAB)

MLP 2248
(MBL)

MLP 2249
(GUNMETAL)

Mortise lock prime roller

- backset 50mm
- SUS 304



Available
MLP 2237 (AB)

MLP 2231
(PVD SG)

MLP 2232
(SSS)

MLP 2233
(SSS)

MLP 2238
(MBL)

MLP 2239
(GUNMETAL)

Mortise lock prime roller

- backset 40mm
- SUS 304



Available
MLP 2227 (AB)

MLP 2221
(PVD SG)

MLP 2222
(SSS)

MLP 2223
(SSS)

MLP 2228
(MBL)

MLP 2229
(GUNMETAL)

MORTISE LOCK ROLLER

Mortise lock standard roller 60mm

- backset 60mm
- stainless steel



MLP 141
(PVD)



MLP 142
(SSS)



MLP 143
(RAB)

Mortise lock standard roller 50mm

- backset 50mm
- stainless steel



MLP 132
(SSS)



MLP 133
(RAB)

Mortise lock standard roller 40mm

- backset 40mm
- stainless steel



MLP 121
(PVD)



MLP 122
(SSS)

MORTISE LOCK ROLLER LATCH

Mortise lock prime roller latch

- adjustable
- SUS 304



MLP 2711
(PVD SG)



MLP 2712
(SSS)



MLP 2713
(RAB)



MLP 2718
(MBL)



MLP 2719
(GUNMETAL)

MORTISE LOCK SET

Mortise lock set eco swing

- backset 40mm
- cylinder DC-SK 60mm
- stainless steel



MSP 092
(SSS)

Mortise lock set standard roller

- backset 40/50mm
- cylinder DC-SK 60mm
- stainless steel



MSP 192
40mm (SSS)



MSP 182
50mm (SSS)

Mortise lock set lite swing 40mm

- backset 40mm
- double cylinder 60mm
- standard key
- SUS 304

Available

- MSP 1123 (RAB, 40mm)
- MSP 1132 (SSS, 50mm)
- MSP 1133 (RAB, 50mm)
- MSP 1138 (MBL, 50mm)
- MSP 1139 (GUNMETAL, 50mm)



MSP 1122
(SSS)



MSP 1128
(MBL)



MSP 1129
(GUNMETAL)

Mortise lock set lite roller 50mm

- backset 50mm
- double cylinder 60mm
- standard key
- SUS 304

Available

- MSP 1222 (SSS, 40mm)
- MSP 1223 (RAB, 40mm)
- MSP 1228 (MBL, 40mm)
- MSP 1229 (GUNMETAL, 40mm)
- MSP 1233 (RAB, 50mm)



MSP 1232
(SSS)



MSP 1238
(MBL)



MSP 1239
(GUNMETAL)

MORTISE LOCK SLIDING

Mortise lock prime sliding 50mm

· SUS 304



Available
MLP 2337 (AB)

MLP 2331
(PVD SG)

MLP 2332
(SSS)

MLP 2333
(RAB)

MLP 2338
(MBL)

MLP 2339
(GUNMETAL)

Mortise lock prime sliding 40mm

· SUS 304



Available
MLP 2327 (AB)

MLP 2321
(PVD SG)

MLP 2322
(SSS)

MLP 2323
(RAB)

MLP 2328
(MBL)

MLP 2329
(GUNMETAL)

Mortise lock prestige sliding 50MM

· backset 50mm
· SUS 304



MLP 3332
(SSS)

MLP 3338
(MBL)

Mortise lock prestige sliding 30MM

· backset 30mm
· SUS 304



MLP 3312
(SSS)

MLP 3318
(MBL)

Mortise lock deluxe sliding 50mm

· backset 50mm
· SUS 304



MLP 632
(SSS)

MLP 633
(RAB)

MLP 638
(MBL)

MORTISE LOCK SLIDING

Mortise lock deluxe sliding 40mm

- backset 40mm
- SUS 304



MLP 621
(PVD)



MLP 622
(SSS)



MLP 623
(RAB)

Mortise lock deluxe sliding 30mm

- backset 30mm
- SUS 304



MLP 612
(SSS)

Available
MLP 617 (AB)

Mortise lock standard sliding 40mm

- backset 40mm
- stainless steel



MLP 222
(SSS)

Available
MLP 232 (SSS, 50MM)
MLP 238 (MBL, 50MM)

MORTISE LOCK DEADBOLT

Mortise lock prestige deadbolt

- only deadbolt
- backset 60mm
- SUS 304



MLP 3642
(SSS)



MLP 3648
(MBL)

Mortise lock prestige deadbolt

- only deadbolt
- backset 50mm
- SUS 304



MLP 3632
(SSS)



MLP 3638
(MBL)

Mortise lock prestige deadbolt

- only deadbolt
- backset 40mm
- SUS 304



MLP 3622
(SSS)



MLP 3628
(MBL)

PALOMA[®]

HIGH QUALITY ARCHITECTURAL HARDWARE

CYLINDER



Cylinder exclusive KC-CK

- made in Italy
- computer key
- euro brass



Computer key



CLP 9202
(60MM, PB)



CLP 9204
(60MM, SN)



CLP 9205
(60MM, AB)



CLP 9206
(60MM, MBL)



CLP 9232
(70MM, PB)



CLP 9234
(70MM, SN)



CLP 9235
(70MM, AB)



CLP 9236
(70MM, MBL)

KNOB CYLINDER - COMPUTER KEY

Cylinder deluxe KC-CK

- computer key
- euro brass



Computer key



CLP 613
(62MM, SB)



CLP 614
(62MM, SN)



CLP 615
(62MM, AB)



CLP 616
(62MM, MBL)



CLP 617
(62MM, GM)



CLP 618
(62MM, AC)



CLP 619
(62MM, WH)



CLP 633
(70MM, SB)



CLP 634
(70MM, SN)



CLP 635
(70MM, AB)



CLP 636
(70MM, MBL)



CLP 637
(70MM, GM)



CLP 638
(70MM, AC)



CLP 639
(70MM, WH)



CLP 643
(80MM, SB)



CLP 644
(80MM, SN)



CLP 645
(80MM, AB)



CLP 646
(80MM, MBL)



CLP 647
(80MM, GUNMETAL)



CLP 656
(100MM, MBL)



CLP 657
(100MM, GUNMETAL)



CLP 666
(120MM, MBL)

KNOB CYLINDER - STANDARD KEY

Cylinder deluxe KC-SK

- standard key
- euro brass



Standard key



CLP 403
(60MM, SB)



CLP 404
(S60MM, N)



CLP 405
(60MM, AB)



CLP 406
(60MM, MBL)



CLP 407
(60MM, GUNMETAL)



CLP 433
(70MM, SB)



CLP 434
(70MM, SN)



CLP 435
(70MM, AB)



CLP 436
(70MM, MBL)



CLP 437
(70MM, GUNMETAL)



CLP 454
(100MM, SN)

Cylinder lite KC-SK

- standard key
- zamak-3 + brass



Standard key



CLP 1204
(60MM, SN)



CLP 1205
(60MM, AB)



CLP 1206
(60MM, MBL)



CLP 1207
(60MM, GUNMETAL)



CLP 1234
(70MM, SN)



CLP 1235
(70MM, AB)



CLP 1236
(70MM, MBL)



CLP 1237
(70MM, GUNMETAL)

Cylinder superior KC-SK

- standard key
- brass



Standard key



CLP 494
(60MM, SN)

Cylinder superior KC-NK

- non key
- brass



CLP 794
(60MM, SN)

Cylinder exclusive KC-NK

- made in Italy
- non key
- euro brass



CLP 9302
(60MM, PB)



CLP 9304
(60MM, SN)



CLP 9305
(60MM, AB)



CLP 9306
(60MM, MBL)



CLP 9332
(70MM, PB)



CLP 9334
(70MM, SN)



CLP 9335
(70MM, AB)



CLP 9336
(70MM, MBL)

KNOB CYLINDER - NON KEY

Cylinder deluxe KC-NK

- non key
- euro brass



CLP 713
(62MM, SB)



CLP 714
(62MM, SN)



CLP 715
(62MM, AB)



CLP 716
(62MM, MBL)



CLP 717
(62MM, GUNMETAL)



CLP 733
(70MM, SB)



CLP 734
(70MM, SN)



CLP 735
(70MM, AB)



CLP 736
(70MM, MBL)



CLP 737
(70MM, GUNMETAL)

Cylinder lite KC-NK

- non key
- zamak-3 + brass



CLP 1304
(60MM, SN)



CLP 1305
(60MM, AB)



CLP 1306
(60MM, MBL)



CLP 1307
(60MM, GUNMETAL)



CLP 1334
(70MM, SN)



CLP 1335
(70MM, AB)



CLP 1336
(70MM, MBL)



CLP 1337
(70MM, GUNMETAL)

Cylinder exclusive DC-CK

- made in Italy
- computer key
- euro brass



Computer key



CLP 9102
(60MM, PB)



CLP 9104
(60MM, SN)



CLP 9105
(60MM, AB)



CLP 9106
(60MM, MBL)



CLP 9132
(70MM, PB)



CLP 9134
(70MM, SN)



CLP 9135
(70MM, AB)



CLP 9136
(70MM, MBL)



CLP 9142
(80MM, PB)



CLP 9144
(80MM, SN)



CLP 9145
(80MM, AB)



CLP 9146
(80MM, MBL)

DOUBLE CYLINDER - COMPUTER KEY

Cylinder deluxe DC-CK

- computer key
- euro brass



Computer key **CLP 513** (62MM, SB) **CLP 514** (62MM, SN) **CLP 515** (62MM, AB) **CLP 516** (62MM, MBL) **CLP 517** (62MM, GM) **CLP 518** (62MM, AC) **CLP 519** (62MM, WH)



CLP 533 (70MM, SB) **CLP 534** (70MM, SN) **CLP 535** (70MM, AB) **CLP 536** (70MM, MBL) **CLP 537** (70MM, GM) **CLP 538** (70MM, AC) **CLP 539** (70MM, WH)

Cylinder deluxe DC-CK

- computer key
- euro brass



Computer key **CLP 543** (80MM, SB) **CLP 544** (80MM, SN) **CLP 545** (80MM, AB) **CLP 546** (80MM, MBL) **CLP 547** (80MM, GUNMETAL)



CLP 553 (100MM, SB) **CLP 554** (100MM, SN) **CLP 555** (100MM, AB) **CLP 556** (100MM, MBL) **CLP 557** (100MM, GUNMETAL)



CLP 563 (120MM, SB) **CLP 564** (120MM, SN) **CLP 565** (120MM, AB) **CLP 566** (120MM, MBL)



CLP 567 (120MM, GUNMETAL)

DOUBLE CYLINDER - COMPUTER KEY

Cylinder superior DC-CK

- computer key
- euro brass



Computer key



CLP 213
(62MM, SB)



CLP 214
(62MM, SN)



CLP 215
(62MM, AB)

DOUBLE CYLINDER - STANDARD KEY

Cylinder deluxe DC-SK

- standard key
- euro brass



Standard key



CLP 303
(60MM, SB)



CLP 304
(60MM, SN)



CLP 305
(60MM, AB)



CLP 306
(60MM, MBL)



CLP 307
(60MM, GUNMETAL)



CLP 333
(70MM, SB)



CLP 334
(70MM, SN)



CLP 335
(70MM, AB)



CLP 336
(70MM, MBL)



CLP 337
(70MM, GUNMETAL)



CLP 343
(80MM, SB)



CLP 344
(80MM, SN)



CLP 345
(80MM, AB)



CLP 346
(80MM, MBL)



CLP 347
(80MM, GUNMETAL)

DOUBLE CYLINDER - STANDARD KEY

Cylinder lite DC-SK

- standard key
- zamak-3 + brass



Standard key



CLP 1104
(60MM, SN)



CLP 1105
(60MM, AB)



CLP 1106
(60MM, MBL)



CLP 1107
(60MM, GUNMETAL)



CLP 1134
(70MM, SN)



CLP 1135
(70MM, AB)



CLP 1136
(70MM, MBL)



CLP 1137
(70MM, GUNMETAL)

Cylinder superior DC-SK

- standard key
- brass



Standard key



CLP 394
(60MM, SN)

Cylinder deluxe DC-SK

- standard key
- euro brass



Standard key



CLP 324
(65MM, SN)

Cylinder standard DC-SK

- standard key
- zamak alloy



Standard key



CLP 104
(60MM, SN)

Cylinder standard DC-SK

- standard key
- zamak alloy



Standard key



CLP 124
(65MM, SN)

HALF CYLINDER - STANDARD KEY

Cylinder prime HC-SK

- standard key
- brass



CLP 2403
(30+10MM, SB)



CLP 2404
(30+10MM, SN)



CLP 2405
(30+10MM, AB)



CLP 2406
(30+10MM, MBL)



CLP 2407
(30+10MM, GUNMETAL)



Standard key



CLP 2433
(35+10MM, SB)



CLP 2434
(35+10MM, SN)



CLP 2435
(35+10MM, AB)



CLP 2436
(35+10MM, MBL)



CLP 2437
(35+10MM, GUNMETAL)

HALF CYLINDER - KNOB CYLINDER

Cylinder prime HC-KC

- non key
- brass



CLP 2503
(30+10MM, SB)



CLP 2504
(30+10MM, SN)



CLP 2505
(30+10MM, AB)



CLP 2506
(30+10MM, MBL)



CLP 2507
(30+10MM, GUNMETAL)



CLP 2533
(35+10MM, SB)



CLP 2534
(35+10MM, SN)



CLP 2535
(35+10MM, AB)



CLP 2536
(35+10MM, MBL)



CLP 2537
(35+10MM, GUNMETAL)

HALF CYLINDER - STANDARD KEY

Cylinder deluxe HC-SK 40mm

- standard key
- brass



Standard key



CLP 042
(SN)

Cylinder deluxe HC-SK 50mm

- standard key
- brass



Standard key



CLP 052
(SN)

HINGES



BUTT HINGE BRASS

Butt hinge brass

- polished brass (PB)
- brass



BHP 602
3"X2 5/8"X3MM 2BB
45KG/PAIR



BHP 604
4"X3"X3MM 2BB
70KG/PAIR



BHP 605
4"X3"X4MM 4BB
80KG/PAIR



BHP 606
5"X3"X4MM 2BB
90KG/PAIR



BHP 607
5"X3"X4MM 4BB
90KG/PAIR



BHP 608
6"X3"X4MM 4BB
110KG/PAIR



BHP 609
6"X3,5"X5MM 4BB
120KG/PAIR



BHP 610
8"X3"X4MM 4BB
120KG/PAIR



BHP 611
8"X3,5"X5MM 4BB
130KG/PAIR

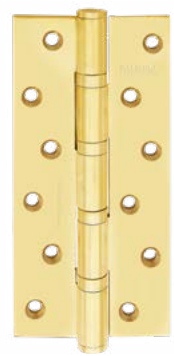

BHP 612
8"X4"X5MM 4BB
130KG/PAIR

Butt hinge brass

- real antique brass (RAB)
- brass



BHP 621
3"X2 5/8"X3MM 2BB
45KG/PAIR



BHP 622
4"X3"X4MM 4BB
80KG/PAIR



BHP 623
5"X3"X4MM 4BB
90KG/PAIR



BHP 624
6"X3,5"X5MM 4BB
120KG/PAIR



BHP 625
8"X3,5"X5MM 4BB
130KG/PAIR



BHP 626
8"X4"X5MM 4BB
130KG/PAIR



BHP 627
8"X3,5"X5MM 5BB
130KG/PAIR



BHP 628
8"X4"X5MM 5BB
130KG/PAIR

BUTT HINGE STAINLESS STEEL SUS 316

Butt hinge exclusive

- satin stainless steel (SSS)
- SUS 316



BHP 101
3"X2,5"X2,5MM 2BB NRP
45KG/PAIR



BHP 102
4"X3"X4MM 4BB NRP
90KG/PAIR



BHP 103
5"X3"X4MM 4BB NRP
100KG/PAIR



BHP 104
6"X3,5"X4MM 4BB NRP
110KG/PAIR



BHP 105
6"X3,5"X5MM 4BB NRP
120KG/PAIR



BHP 106
6"X4"X4MM 4BB NRP
120KG/PAIR



BHP 107
8"X4"X4MM 6BB NRP
130KG/PAIR

Butt hinge exclusive

- fire resistant
- satin stainless steel (SSS)
- SUS 316



BHP 111
3"X2,5"X2,5MM 2BB NRP (NEW)
45KG/PAIR



BHP 112
4"X3"X4MM 4BB NRP (NEW)
90KG/PAIR



BHP 113
5"X3"X4MM 4BB NRP (NEW)
100KG/PAIR



BHP 114
6"X3,5"X4MM 5BB NRP (NEW)
120KG/PAIR

BUTT HINGE STAINLESS STEEL SUS 304

Butt hinge deluxe

- satin stainless steel (SSS)
- SUS 304



BHP 201
3"X2,5"X2MM 2BB NRP
40KG/PAIR



BHP 202
4"X3"X2MM 2BB NRP
50KG/PAIR



BHP 203
4"X3"X3MM 4BB NRP
80KG/PAIR



BHP 204
5"X3"X3MM 4BB NRP
90KG/PAIR



BHP 205
6"X3"X3MM 4BB NRP
95KG/PAIR

Butt hinge deluxe

- with SP
- satin stainless steel (SSS)
- SUS 304



BHP 211
3"X2,5"X2,5MM 2BB NRP+SP
45KG/PAIR



BHP 212
4"X3"X3MM 4BB NRP+SP
80KG/PAIR



BHP 213
5"X3"X3MM 4BB NRP+SP
90KG/PAIR

Butt hinge deluxe

- fire resistant
- satin stainless steel (SSS)
- SUS 304



BHP 221
3"X2,5"X2MM 2BB NRP
40KG/PAIR



BHP 222
4"X3"X2MM 4BB NRP
50KG/PAIR



BHP 223
4"X3"X3MM 4BB NRP
80KG/PAIR



BHP 224
5"X3"X3MM 4BB NRP
90KG/PAIR



BHP 225
6"X3,5"X4MM 5BB NRP
100KG/PAIR

Butt hinge deluxe

- matte black (MBL)
- SUS 304



BHP 231
3"X2,5"X2MM 2BB NRP
40KG/PAIR



BHP 232
4"X3"X2MM 4BB NRP
50KG/PAIR



BHP 233
4"X3"X3MM 4BB NRP
80KG/PAIR



BHP 234
5"X3"X3MM 4BB NRP
90KG/PAIR



BHP 235
6"X3,5"X4MM 4BB NRP
100KG/PAIR

BUTT HINGE STAINLESS STEEL SUS 304

Butt hinge deluxe

- PVD satin gold
- SUS 304



BHP 241
3"X2,5"X2MM 2BB NRP
40KG/PAIR



BHP 242
4"X3"X2MM 4BB NRP
50KG/PAIR



BHP 243
4"X3"X3MM 4BB NRP
80KG/PAIR



BHP 244
5"X3"X3MM 4BB NRP
90KG/PAIR



BHP 245
6"X3,5"X4MM 4BB NRP
100KG/PAIR

Butt hinge deluxe

- gunmetal
- SUS 304



BHP 251
3"X2,5"X2MM 2BB NRP
40KG/PAIR



BHP 252
4"X3"X2MM 4BB NRP
50KG/PAIR



BHP 253
4"X3"X3MM 4BB NRP
80KG/PAIR



BHP 254
5"X3"X3MM 4BB NRP
90KG/PAIR



BHP 255
6"X3,5"X4MM 4BB NRP
100KG/PAIR

Butt hinge Ultra Power

- max door width: 1200mm
- SUS 304

Available

- BHP 852** (L, SSS)
- BHP 854** (L, MBL)
- BHP 856** (L, GUNMETAL)



BHP 851
5"X4"X3MM UP (R) SS
160KG/PAIR
(SSS)



BHP 853
5"X4"X3MM UP (R) SS
160KG/PAIR
(MBL)



BHP 855
5"X4"X3MM UP (R) SS
160KG/PAIR
(GUNMETAL)

Butt hinge Ultra Power

- max door width: 1400mm
- SUS 304

Available

- BHP 881** (R, SSS)
- BHP 883** (R, MBL)
- BHP 885** (R, GUNMETAL)



BHP 882
8"X4"X4MM UP (L) SS
250KG/PAIR
(SSS)



BHP 884
8"X4"X4MM UP (L) SS
250KG/PAIR
(MBL)



BHP 886
8"X4"X4MM UP (L) SS
250KG/PAIR
(GUNMETAL)

BUTT HINGE STEELINOX STAINLESS STEEL SUS 304

Butt hinge prestige

- satin stainless steel (SSS)
- Steelinox SUS 304



BHP 2731SS
3"X2,5"X2MM 2BB NRP
40KG/PAIR



BHP 2741SS
4"X3"X2MM 4BB NRP
50KG/PAIR



BHP 2742SS
4"X3"X3MM 4BB NRP
80KG/PAIR



BHP 2751SS
5"X3"X3MM 4BB NRP
90KG/PAIR



BHP 2765SS
6"X3,5"X4MM 5BB NRP
100KG/PAIR

Butt hinge prestige

- matte black
- Steelinox SUS 304



BHP 2731MB
3"X2,5"X2MM 2BB NRP
40KG/PAIR



BHP 2741MB
4"X3"X2MM 4BB NRP
50KG/PAIR



BHP 2742MB
4"X3"X3MM 4BB NRP
80KG/PAIR



BHP 2751MB
5"X3"X3MM 4BB NRP
90KG/PAIR



BHP 2765MB
6"X3,5"X4MM 5BB NRP
100KG/PAIR

Butt hinge prestige

- gunmetal
- Steelinox SUS 304



BHP 2731GM
3"X2,5"X2MM 2BB NRP
40KG/PAIR



BHP 2741GM
4"X3"X2MM 4BB NRP
50KG/PAIR



BHP 2742GM
4"X3"X3MM 4BB NRP
80KG/PAIR



BHP 2751GM
5"X3"X3MM 4BB NRP
90KG/PAIR



BHP 2765GM
6"X3,5"X4MM 5BB NRP
100KG/PAIR

BUTT HINGE STAINLESS STEEL

Butt hinge lite

- satin stainless steel (SSS)
- stainless steel



BHP 3731SS
3"x2,5"x2MM 2BB NRP
40KG/PAIR



BHP 3741SS
4"x3"x2MM 4BB NRP
50KG/PAIR



BHP 3742SS
4"x3"x3MM 4BB NRP
80KG/PAIR



BHP 3751SS
5"x3"x3MM 4BB NRP
90KG/PAIR

Butt hinge lite

- matte black
- stainless steel



BHP 3731MB
3"x2,5"x2MM 2BB NRP
40KG/PAIR



BHP 3741MB
4"x3"x2MM 4BB NRP
50KG/PAIR



BHP 3742MB
4"x3"x3MM 4BB NRP
80KG/PAIR



BHP 3751MB
5"x3"x3MM 4BB NRP
90KG/PAIR

Butt hinge lite

- gunmetal
- stainless steel



BHP 3731GM
3"x2,5"x2MM 2BB NRP
40KG/PAIR



BHP 3741GM
4"x3"x2MM 4BB NRP
50KG/PAIR



BHP 3742GM
4"x3"x3MM 4BB NRP
80KG/PAIR



BHP 3751GM
5"x3"x3MM 4BB NRP
90KG/PAIR

BUTT HINGE STEELINOX STAINLESS STEEL SUS 304 (SPECIFICALLY FOR THE PROJECT)

Butt hinge prestige

- satin stainless steel (SSS)
- Steelinox SUS 304



BHP 2631SS
3"x2,5"x2MM 2BB NRP
40KG/PAIR



BHP 2641SS
4"x3"x2MM 4BB NRP
50KG/PAIR



BHP 2642SS
4"x3"x3MM 4BB NRP
80KG/PAIR



BHP 2651SS
5"x3"x3MM 4BB NRP
90KG/PAIR



BHP 2665SS
6"x3,5"x4MM 5BB NRP
100KG/PAIR



BHP 2685SS
8"x4"x4MM 6BB NRP
130KG/PAIR

Butt hinge prestige

- matte black
- Steelinox SUS 304



BHP 2631MB
3"x2,5"x2MM 2BB NRP
40KG/PAIR



BHP 2641MB
4"x3"x2MM 4BB NRP
50KG/PAIR



BHP 2642MB
4"x3"x3MM 4BB NRP
80KG/PAIR



BHP 2651MB
5"x3"x3MM 4BB NRP
90KG/PAIR



BHP 2665MB
6"x3,5"x4MM 5BB NRP
100KG/PAIR



BHP 2685MB
8"x4"x4MM 6BB NRP
130KG/PAIR

Butt hinge prestige

- gunmetal
- Steelinox SUS 304



BHP 2631GM
3"x2,5"x2MM 2BB NRP
40KG/PAIR



BHP 2641GM
4"x3"x2MM 4BB NRP
50KG/PAIR



BHP 2642GM
4"x3"x3MM 4BB NRP
80KG/PAIR



BHP 2651GM
5"x3"x3MM 4BB NRP
90KG/PAIR



BHP 2665GM
6"x3,5"x4MM 5BB NRP
100KG/PAIR



BHP 2685GM
8"x4"x4MM 6BB NRP
130KG/PAIR

BUTT HINGE STAINLESS STEEL (SPECIFICALLY FOR THE PROJECT)

Butt hinge lite

- satin stainless steel (SSS)
- stainless steel



BHP 3631SS
3"x2,5"x2MM 2BB NRP
40KG/PAIR



BHP 3641SS
4"x3"x2MM 4BB NRP
50KG/PAIR



BHP 3642SS
4"x3"x3MM 4BB NRP
80KG/PAIR



BHP 3651SS
5"x3"x3MM 4BB NRP
90KG/PAIR

Butt hinge lite

- matte black
- stainless steel



BHP 3631MB
3"x2,5"x2MM 2BB NRP
40KG/PAIR



BHP 3641MB
4"x3"x2MM 4BB NRP
50KG/PAIR



BHP 3642MB
4"x3"x3MM 4BB NRP
80KG/PAIR



BHP 3651MB
5"x3"x3MM 4BB NRP
90KG/PAIR

Butt hinge lite

- gunmetal
- stainless steel



BHP 3631GM
3"x2,5"x2MM 2BB NRP
40KG/PAIR



BHP 3641GM
4"x3"x2MM 4BB NRP
50KG/PAIR



BHP 3642GM
4"x3"x3MM 4BB NRP
80KG/PAIR



BHP 3651GM
5"x3"x3MM 4BB NRP
90KG/PAIR

BUTT HINGE STAINLESS STEEL

Butt hinge superior

- satin stainless steel (SSS)
- stainless steel



BHP 302
3"X2,5"X2MM 2BB
40KG/PAIR



BHP 304
4"X3"X2MM 2BB
50KG/PAIR



BHP 305
4"X3"X3MM 4BB
80KG/PAIR



BHP 306
5"X3"X3MM 4BB
90KG/PAIR

Butt hinge essential

- satin stainless steel (SSS)
- stainless steel



BHP 411
3"X2,5"X2MM 2BB
30KG/PAIR



BHP 412
4"X3"X2MM 2BB
40KG/PAIR



BHP 413
4"X3"X3MM 4BB
70KG/PAIR



BHP 414
5"X3"X3MM 4BB
80KG/PAIR

Butt hinge eco

- satin stainless steel (SSS)
- stainless steel



BHP 701
3"X2,5"X2MM 2BR
30KG/PAIR



BHP 702
4"X3"X2MM 4BR
40KG/PAIR



BHP 703
4"X3"X3MM 4BR
50KG/PAIR



BHP 704
5"X3"X3MM 4BR
60KG/PAIR

Butt hinge essential

- satin stainless steel (SSS)
- stainless steel



BHP 423
4"X3"X3MM 2BB SSS
70KG/PAIR

INVISIBLE HINGE STAINLESS STEEL SUS 304

Invisible hinge P100

- max. weight 100KG/2pcs
- SUS 304



IHP 302
(SSS)



IHP 311
(SSS)



IHP 312
(SATIN BLACK)



IHP 313
(PVD SATIN GOLD)

Invisible hinge P100N

- max. weight 100KG/2pcs
- SUS 304



IHP 321
(SSS)



IHP 322
(SATIN BLACK)



IHP 324
(GUNMETAL)

Invisible hinge P200N

- max. weight 200KG/2pcs
- SUS 304



IHP 331
(SSS)



IHP 332
(SATIN BLACK)



IHP 333
(SATIN GOLD)



IHP 334
(GUNMETAL)

Invisible hinge P50

- max. weight 50KG/2pcs
- SUS 304



IHP 212
(SSS)

Invisible hinge P65

- max. weight 65KG/2pcs
- SUS 304



IHP 213
(SSS)

INVISIBLE HINGE SUPERALUM

Invisible hinge P40

- max door weight: 40kg/2pcs
- max door height: 2500mm/3pcs
- min door thickness: 33-45mm
- opening angle: 165°
- 3D adjustable
- aluminium



IHP 801
(NA)



IHP 804
(MBL)



IHP 807
(MWH)

Invisible hinge PL40

- max door weight: 40kg/2pcs
- max door height: 2500mm/3pcs
- min door thickness: 33-45mm
- opening angle: 165°
- 3D adjustable
- aluminium + SUS 304



IHP 811
(NA)



IHP 814
(MBL)



IHP 817
(MWH)



IHP 821
(GUNMETAL)

Invisible hinge P80

- max door weight: 80kg/2pcs
- max door height: 2500mm/3pcs
- min door thickness: 36-50mm
- opening angle: 165°
- 3D adjustable
- aluminium



IHP 802
(NA)



IHP 805
(MBL)



IHP 808
(MWH)

Invisible hinge PL80

- max door weight: 80kg/2pcs
- max door height: 2500mm/3pcs
- min door thickness: 36-50mm
- opening angle: 165°
- 3D adjustable
- aluminium + SUS 304



IHP 812
(NA)



IHP 815
(MBL)



IHP 818
(MWH)



IHP 822
(GUNMETAL)

Invisible hinge P120

- max door weight: 120kg/2pcs
- max door height: 2500mm/3pcs
- min door thickness: 42-60mm
- opening angle: 165°
- 3D adjustable
- aluminium



IHP 803
(NA)



IHP 806
(MBL)



IHP 809
(MWH)

Invisible hinge PL120

- max door weight: 120kg/2pcs
- max door height: 2500mm/3pcs
- min door thickness: 42-60mm
- opening angle: 165°
- 3D adjustable
- aluminium + SUS 304



IHP 813
(NA)



IHP 816
(MBL)



IHP 819
(MWH)



IHP 823
(GUNMETAL)

PIVOT HINGE

Pivot hinge 001

- max door weight: 50kg
- min door thickness: 30mm
- SUS 304

Top pivot



Bottom pivot



PVP 101
(SSS)

Pivot hinge 501

- max door weight: 250kg
- max door width: 1100mm
- min door thickness: 40mm
- SUS 304

Top pivot



Bottom pivot



PVP 501
(SSS)

Pivot hinge 002

- max door weight: 45kg
- min door thickness: 30mm
- brass

Top pivot



Bottom pivot



PVP 201
(PB)

Top pivot



Bottom pivot



PVP 502
(SN)

Pivot hinge 006 offset

- max door weight: 120kg
- max door width: 1200mm
- min door thickness: 30mm
- SUS 304 + iron

Top pivot



Bottom pivot



PVP 601
(SSS)

Top pivot



Bottom pivot



PVP 602
(SSS)

PIVOT HINGE STAINLESS STEEL

Pivot hinge 300 HD

- max door weight: 300kg
- max door width: 1500mm
- min door thickness: 55mm
- SUS 304 + steel

Top pivot

Bottom pivot



PVP 831
(SSS)

Pivot hinge 800 HD

- max door weight: 800kg
- max door width: 1500mm
- min door thickness: 80mm
- SUS 304 + steel

Top pivot

Bottom pivot



PVP 881
(SSS)

Pivot hinge 900 HD

- max door weight: 900kg
- max door width: 1500mm
- min door thickness: 60mm
- solid SUS 304

Top pivot

Bottom pivot



PVP 891
(SSS)

Pivot hinge 900 UP

- max door weight: 900kg
- max door width: 1500mm
- min door thickness: 70mm
- solid SUS 304

Top pivot

Bottom pivot



PVP 892
(SSS)

PIVOT HINGE STAINLESS STEEL

Pivot hinge 400 HD

- max door weight: 400kg
- max door width: 1500mm
- min door thickness: 50mm
- solid SUS 304

Top pivot



Bottom pivot



PVP 841
(SSS)

Pivot hinge 600 HD

- max door weight: 600kg
- max door width: 1500mm
- min door thickness: 50mm
- solid SUS 304

Top pivot



Bottom pivot



PVP 861
(SSS)

Pivot hinge 600 UP

- max door weight: 600kg
- max door width: 1500mm
- min door thickness: 60mm
- solid SUS 304

Top pivot



Bottom pivot



PVP 862
(SSS)

Pivot hinge 9985 hydraulic

- max door weight: 85kg
- max door width: 800-950mm
- min door thickness: 45mm
- SUS 304 + aluminium

Top pivot



Bottom pivot



PVP 901
(Na+SSS)

DOOR
ACCESSORIES



DOOR CLOSER

Door closer 900-NHO

- max door weight: 40kg
- max door width: 800mm
- aluminium



DCP 101
(NA)



DCP 102
(BA)



DCP 103
(MBL)



DCP 104
(WHITE)

Door closer 900-HO

- max door weight: 40kg
- max door width: 800mm
- aluminium



DCP 111
(NA)



DCP 112
(BA)



DCP 113
(MBL)



DCP 114
(WHITE)

Door closer 956-NHO

- max door weight: 100kg
- max door width: 1000mm
- aluminium



DCP 301
(NA)



DCP 302
(MBL)

Door closer 9557-NHO

- max door weight: 150kg
- max door width: 1000mm
- aluminium



DCP 311
(NA)



DCP 312
(MBL)

Door closer 9516-NHO

- max door weight: 20-150kg
- max door width: 1200mm
- aluminium



DCP 321
(NA)



DCP 322
(MBL)

Door closer 925-NHO

- max door weight: 40-100kg
- max door width: 1000mm
- aluminium



DCP 401
(NA)



DCP 402
(MBL)

DOOR CLOSER

Door closer 925-sliding arm

- max door weight: 60kg
- max door width: 900mm
- aluminium



DCP 411
(NA)



DCP 412
(MBL)

Door closer 993-concealed

- max door weight: 50kg
- max door width: 800mm
- min door thickness: 40mm
- aluminium



DCP 501
(NA)



DCP 502
(MBL)

Door closer 992-concealed

- max door weight: 70kg
- max door width: 900mm
- min door thickness: 45mm
- aluminium



DCP 511
(NA)



DCP 512
(MBL)

Door closer 935-concealed

- max door weight: 90kg
- max door width: 1000mm
- min door thickness: 40mm
- aluminium



DCP 521
(NA)



DCP 522
(MBL)

DOOR STOP

Door stop magnet 003

· brass



Door stop wall 013

· SUS 304



Door stop hook 005

· SUS 304



DSP 201 (SSS)

Door stop injak 008

· SUS 304



DSP 211 (SSS)

Door stop floor 016

· SUS 304



DSP 232 (SSS)

Door stop floor 017

· SUS 304



DSP 233 (SSS)

DSP 237 (MBL)

DSP 238 (GUNMETAL)

DSP 239 (PVD SG)

DOOR STOP

Door stop magnet 025
· SUS 304



DSP 241
(SSS)

Door stop magnet 027
· SUS 304



DSP 243
(SSS)

Door stop magnet 026
· SUS 304



DSP 242
(SSS)

DSP 245
(MBL)

Door stop magnet 014
· Stainless steel



DSP 401
(SSS)

Door stop floor 023
· SUS 304 + aluminium



DSP 234
(SSS)

Door stop floor 025 70mm
· SUS 304



DSP 235
(SSS)

Door stop floor 026 70mm
· SUS 304 + aluminium



DSP 236
(SSS)

DOOR STOP

Door stop magnet 009

· zamak alloy



DSP 704
(GP)



DSP 705
(SN)



DSP 707
(RAB)

Door stop hook 010

· zamak alloy



DSP 711
(GP)



DSP 712
(SN)

Door stop floor 001

· zamak alloy



DSP 721
(GP)



DSP 722
(SN)



DSP 723
(AB)



DSP 724
(MBL)



DSP 725
(GUNMETAL)

Door stop magnet 012

· zamak alloy



DSP 708
(SN)

Door stop floor 022

· rubber



DSP 001
(WHITE)



DSP 002
(BLACK)

Door stop floor 024

· rubber



DSP 003
(BLACK)

DOOR VIEWER

Door viewer exclusive 200

· brass



DVP 601
(GP)



DVP 602
(SN)



DVP 603
(CH)



DVP 604
(MBL)

Door viewer deluxe 180

· brass



DVP 301
(GP)



DVP 302
(SN)



DVP 303
(CH)



DVP 304
(MBL)

ROLLER CATCH

Roller catch PLM-500

· SUS 304



RCP 201
(SSS)



RCP 202
(MBL)



RCP 203
(SG)



RCP 204
(GUNMETAL)



RCP 205
(AB)

DOOR BOLT

Door bolt 203
· SUS 304



DBP 221
(SSS)

Door bolt 201
· SUS 304



DBP 201
(SSS)

Door bolt 202
· SUS 304



DBP 211
(SSS)

DOOR CHAIN

Door chain 702
· zamak alloy



DHP 706
(GP)

DHP 707
(SN)

Door chain 201
· SUS 304



DHP 201
(SSS)

DOOR GUARD

Door guard 702
· zamak alloy

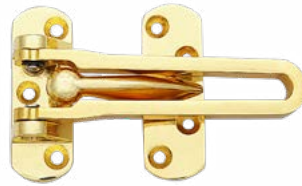

DGP 701
(GP)



DGP 702
(SN)

Door guard 201
· SUS 304



DGP 202
(SSS)

DUST PROOF

Dust proof 601
· brass



DPP 601
(PB)



DPP 602
(SN)

Dust proof 201
· SUS 304



DPP 201
(SSS)



DPP 202
(MBL)

FLUSH BOLT

Flush bolt Silca SQ

- suitable for steel door
- zinc alloy



FBP 801
(SILVER, 250MM)

FBP 802
(SILVER, 350MM)

Flush bolt Enrico OV

- suitable for aluminium door
- zinc alloy



FBP 812
(NA, 350MM)

FBP 814
(MBL, 350MM)

FBP 811
(NA, 250MM)

FBP 813
(MBL, 250MM)

Flush bolt Sabrina 6"

- brass



FBP 601
(PB)

FBP 602
(SN)

FBP 604
(RAB)

Flush bolt Sabrina 6"+12"

- brass



FBP 605
(PB)

FBP 606
(SN)

FBP 608
(RAB)

Flush bolt Sabrina 6"+18"

- brass



FBP 609
(PB)

FBP 610
(SN)

FBP 612
(RAB)

Available 6"+24":
FBP 613 (PB)
FBP 614 (SN)
FBP 616 (RAB)

Available 6"+36":
FBP 617 (PB)
FBP 618 (SN)
FBP 620 (RAB)

Available 6"+48":
FBP 621 (PB)
FBP 622 (SN)
FBP 624 (RAB)
FBP 629 (AB)

Available 6"+60":
FBP 625 (PB)
FBP 626 (SN)
FBP 628 (RAB)
FBP 630 (AB)

FLUSH BOLT

Flush bolt Futura 8"

· SUS 304



FBP 211
(SSS)



FBP 221
(MBL)

Flush bolt Futura 8"+12"

· SUS 304



FBP 212
(SSS)



FBP 222
(MBL)

Flush bolt Futura 8"+18"

· SUS 304



FBP 213
(SSS)



FBP 223
(MBL)

Flush bolt Futura 8"+24"

· SUS 304



FBP 214
(SSS)



FBP 224
(MBL)

Available 8"+40":
FBP 215 (SSS)
FBP 225 (MBL)

Available 8"+48":
FBP 216 (SSS)
FBP 226 (MBL)

Available 8"+60":
FBP 217 (SSS)
FBP 227 (MBL)

FLUSH BOLT

Flush bolt Futura 8"

· SUS 304



FBP 241
(GUNMETAL)

Flush bolt Futura 8"+12"

· SUS 304



FBP 242
(GUNMETAL)

Flush bolt Futura 8"+18"

· SUS 304



FBP 243
(GUNMETAL)

Flush bolt Futura 8"+24"

· SUS 304



FBP 244
(GUNMETAL)

Available 8"+40":
FBP 245
(GUNMETAL)

Available 8"+48":
FBP 246
(GUNMETAL)

Available 8"+60":
FBP 247
(GUNMETAL)

FLUSH BOLT

Flush bolt Colombo 8"

· SUS 304



FBP 201
(SSS)

Flush bolt Colombo 8"+12"

· SUS 304



FBP 202
(SSS)

Flush bolt Colombo 8"+18"

· SUS 304



Available 8"+24":
FBP 204 (SSS)

FBP 203
(SSS)

Flush bolt Plate 8"

· SUS 304



FBP 311
(SSS)

Flush bolt Automatic (R)

· SUS 304



FBP 231
(SSS)

Flush bolt Automatic (L)

· SUS 304



FBP 232
(SSS)

BARREL BOLT

Barrel bolt Pinax 2"

· brass



BBP 608
(SN)

BBP 622
(RAB)

Barrel bolt Pinax 3"

· brass



BBP 609
(SN)

BBP 623
(RAB)

Barrel bolt Pinax 6"

· brass



Available 12":
BBP 611 (SN)
BBP 625 (RAB)

BBP 610
(SN)

BBP 624
(RAB)

Barrel bolt Wales 2"

· brass

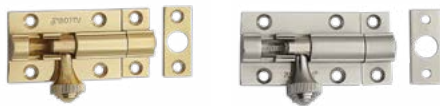

BBP 631
(PB)

BBP 635
(SN)

Barrel bolt Wales 3"

· brass



BBP 632
(PB)

BBP 636
(SN)

Barrel bolt Wales 6"

· brass



Available 12":
BBP 634 (PB)
BBP 638 (SN)

BBP 633
(PB)

BBP 637
(SN)

BARREL BOLT

Barrel bolt Beta 2"

· SUS 304



BBP 201
(SSS)

Barrel bolt Beta 3"

· SUS 304



BBP 202
(SSS)

Barrel bolt Lisbon 2"

· stainless steel



BBP 411
(SSS)

Barrel bolt Lisbon 3"

· stainless steel



BBP 412
(SSS)

Barrel bolt Lisbon 6"

· stainless steel



Available 12":
BBP 414 (SSS)

BBP 413
(SSS)

Barrel bolt Malta 2"

· aluminium



BBP 801
(NA)



BBP 811
(MBL)

Barrel bolt Malta 3"

· aluminium



BBP 802
(NA)



BBP 812
(MBL)

Barrel bolt Malta 6"

· aluminium



Available 12":
BBP 804 (NA)
BBP 814 (MBL)

BBP 803
(NA)



BBP 813
(MBL)

WINDOW ACCESSORIES



WINDOW HOOK

Window hook brass 602-8"-SG6

· brass



WHP 621
(PB)



WHP 624
(SN)



WHP 633
(AB)



WHP 642
(MBL)

Window hook brass 602-10"-SG6

· brass



WHP 622
(PB)



WHP 625
(SN)



WHP 634
(AB)



WHP 643
(MBL)

Window hook brass 603-8"-BL

· brass



WHP 651
(PB)



WHP 653
(SN)



WHP 657
(MBL)

Window hook brass 603-10"-BL

· brass



WHP 652
(PB)



WHP 654
(SN)



WHP 658
(MBL)

WINDOW HOOK

Window hook brass 606-8"-SG6

· brass



WHP 644
(MBL)

Window hook brass 606-10"-SG6

· brass



WHP 645
(MBL)

Window hook brass 601-8"-BLS

· brass

Available 6":

WHP 601 (PB)

WHP 604 (SN)

WHP 610 (AB)



WHP 602
(PB)



WHP 605
(SN)



WHP 611
(AB)

Window hook brass 601-10"-BLS

· brass



WHP 603
(PB)



WHP 606
(SN)



WHP 612
(AB)

WINDOW HOOK

Window hook stainless steel 201-8"-SG6

· SUS 304



WHP 201
(SSS)

Window hook stainless steel 201-10"-SG6

· SUS 304



WHP 202
(SSS)

Window hook stainless steel 203-8"-BL

· stainless steel



WHP 221
(SSS)

Window hook stainless steel 203-10"-BL

· stainless steel



WHP 222
(SSS)

Window hook stainless steel 204-8"-SG4

· stainless steel



WHP 231
(SSS)

Window hook stainless steel 204-10"-SG4

· stainless steel



WHP 232
(SSS)

Window hook steel 501-8"-SG6

· steel



WHP 501
(GP)



WHP 503
(SN)



WHP 507
(AB)



WHP 509
(MBL)

WINDOW HOOK

Window hook steel 501-10"-SG6

· steel



WHP 502
(GP)



WHP 504
(SN)



WHP 508
(AB)



WHP 510
(MBL)

Window hook steel 502-8"-BL

· steel



WHP 511
(GP)



WHP 513
(SN)



WHP 517
(AB)



WHP 519
(MBL)

Window hook steel 502-10"-BL

· steel



WHP 512
(GP)



WHP 514
(SN)



WHP 518
(AB)



WHP 520
(MBL)

Window hook steel 503-8"-SG4

· steel



WHP 521
(SN)



WHP 523
(MBL)

Window hook steel 503-10"-SG4

· steel



WHP 522
(SN)



WHP 524
(MBL)

Ramskar 601-TR

· brass



RKP 601
(PB)



RKP 602
(SN)



RKP 604
(RAB)



RKP 605
(MBL)

Ramskar 602-PP

· brass



RKP 611
(PB)



RKP 612
(SN)



RKP 615
(AB)

Ramskar 603-LB

· brass



RKP 621
(PB)



RKP 622
(SN)



RKP 624
(AB)

Ramskar 604-LB

· brass



RKP 631
(PB)



RKP 632
(SN)



RKP 634
(AB)

Ramskar 605-LB

· brass



RKP 641
(PB)



RKP 642
(SN)



RKP 644
(AB)

Ramskar 201-TR

· SUS 304



RKP 201
(SSS)

Ramskar 701-TR

· zamak alloy



RKP 701
(GP)



RKP 702
(SN)

Rambuncis Elisa

· brass



RBP 611
(PB)



RBP 612
(SN)



RBP 614
(AB)



RBP 615
(MBL)

Rambuncis Pavia

· brass



RBP 641
(PB)



RBP 642
(SN)



RBP 644
(AB)



RBP 645
(MBL)

Rambuncis Orlando

· brass

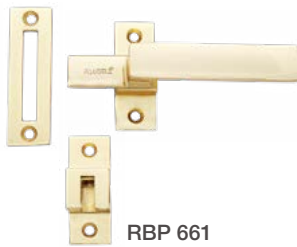

RBP 661
(PB)



RBP 662
(SN)



RBP 664
(RAB)



RBP 665
(MBL)

Rambuncis Oscar

· brass



RBP 602
(SN)



RBP 605
(MBL)

Rambuncis Boston

· brass

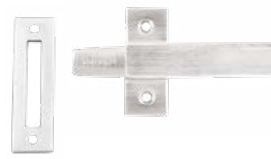

RBP 682
(SN)



RBP 685
(MBL)

RAMBUNCIS

Rambuncis Luna

· brass



RBP 621
(PB)



RBP 622
(SN)



RBP 624
(AB)



RBP 625
(MBL)

Rambuncis Novara

· brass



RBP 651
(PB)



RBP 652
(SN)



RBP 654
(AB)



RBP 655
(MBL)

Rambuncis Futuro

· brass



RBP 671
(PB)



RBP 672
(SN)



RBP 674
(RAB)



RBP 675
(MBL)

CASEMENT HANDLE (ZAMAK ALLOY)



CHP 101 (NA,RIGHT) **CHP 102** (NA,LEFT)



CHP 103 (BLACK, RIGHT) **CHP 104** (BLACK, LEFT)



CHP 105 (WHITE, RIGHT) **CHP 106** (WHITE, LEFT)



CHP 107 (YB1C, RIGHT) **CHP 108** (YB1C, LEFT)

SPRING KNIFE

Spring knife exclusive

· brass

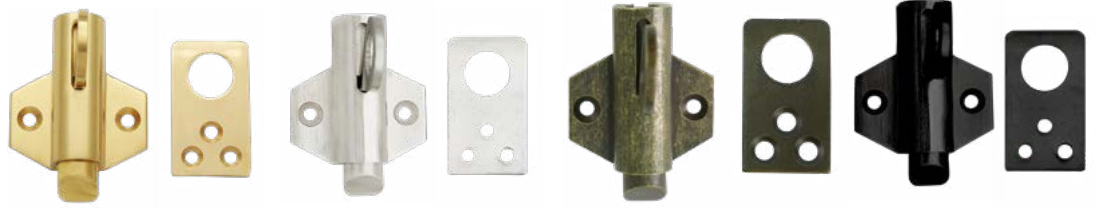

SKP 601
(PB)

SKP 602
(SN)

SKP 604
(RAB)

SKP 605
(MBL)

Spring knife primero-persegi

· brass



SKP 402
(SN)

Spring knife deluxe-persegi

· brass



SKP 302
(SN)

Spring knife superior

· zamak alloy



SKP 201
(GP)

SKP 202
(SN)

SKP 206
(RAB)

Spring knife standard

· zamak alloy

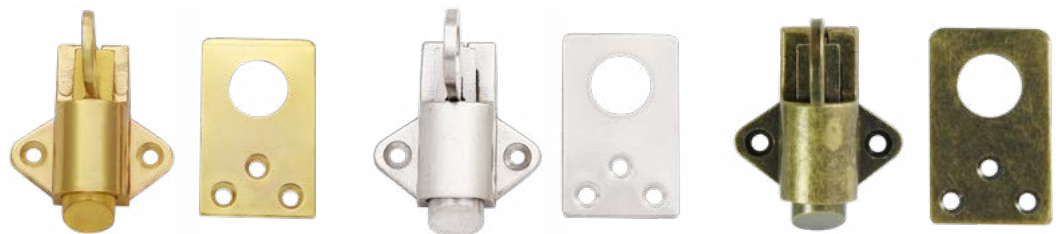

SKP 101
(GP)

SKP 102
(SN)

SKP 106
(RAB)

WINDOW STAY

Window stay 5"

· SUS 304



WSP 201
(SSS)

Window stay 9"

· SUS 304



WSP 211
(SSS)

Window stay 5"

· steel



WSP 502
(SN)



WSP 503
(CH)

Window stay 9"

· steel



WSP 512
(SN)



WSP 513
(CH)

FRICTION STAY

Friction stay superior 12"

· stainless steel



FSP 311
(SSS)



FSP 312
(SSS)



FSP 313
(SSS)



FSP 314
(SSS)



FSP 315
(SSS)

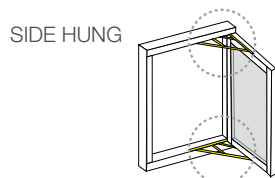
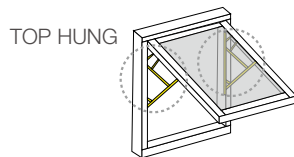

SIDE HUNG & TOP HUNG						
CODE & TYPE	MAX VENT. HEIGHT (MM)	MAX VENT. WIDE (MM)	MAX VENT. WEIGHT (KG)	OPENING ANGLE	NUMBER OF BAR	BAR PLATE THICKNESS
FSP 311 (8")	600	400	6	55°	4	2MM
FSP 312 (10")	700	500	7	90°	4	2MM
FSP 313 (12")	900	600	10	90°	4	2MM
FSP 314 (14")	1000	700	15	90°	4	2.5MM
FSP 315 (16")	1200	800	18	90°	4	2.5MM
TOP HUNG						
FSP 316 (20")	1300	800	22	60°	5	2.5MM
FSP 317 (24")	1500	800	24	55°	5	2.5MM

PADLOCK



PADLOCK ULTRAMARINE SUS 316

Padlock ultramarine short & long

- satin stainless steel (SSS)
- SUS 316



Key hole &
Mechanical key



PLP 7114 (40MM-S) PLP 7124 (40MM-L)



PLP 7115 (50MM-S) PLP 7125 (50MM-L)



PLP 7116 (60MM-S) PLP 7126 (60MM-L)



PLP 7117 (70MM-S) PLP 7127 (70MM-L)

Padlock ultramarine short & long

- satin stainless steel (SSS)
- SUS 316



Key hole &
Mechanical key



PLP 7214 (40MM-S) PLP 7224 (40MM-L)



PLP 7215 (50MM-S) PLP 7225 (50MM-L)



PLP 7216 (60MM-S) PLP 7226 (60MM-L)



PLP 7217 (70MM-S) PLP 7227 (70MM-L)

Padlock steelinox full SUS 304 short & long

- satin stainless steel (SSS)
- steelinox SUS 304



Key hole &
Mechanical key



PLP 6014 (40MM-S) PLP 6024 (40MM-L)



PLP 6015 (50MM-S) PLP 6025 (50MM-L)



PLP 6016 (60MM-S) PLP 6026 (60MM-L)



PLP 6017 (70MM-S) PLP 6027 (70MM-L)

Padlock steelinox full SUS 304 shackle protect

- satin stainless steel (SSS)
- steelinox SUS 304



Key hole & Mechanical key



PLP 6515 (50MM)



PLP 6516 (60MM)

PADLOCK STEEL

Padlock P-500 short

- chrome (CH)
- steel



Keys



PLP 501
(40MM)



PLP 502
(50MM)



PLP 503
(60MM)



PLP 504
(70MM)

Padlock P-500 long

- chrome (CH)
- steel



Keys



PLP 505
(40MM)



PLP 506
(50MM)



PLP 507
(60MM)



PLP 508
(70MM)

Padlock P-500 50MM short

- chrome (CH)
- steel



Master Key



Keys



PLP 532
(50MM-3)



PLP 552
(50MM-5)

Padlock P-500 60MM short

- chrome (CH)
- steel



Master Key



Keys



PLP 533
(60MM-3)



PLP 553
(60MM-5)

SLIDING RAIL

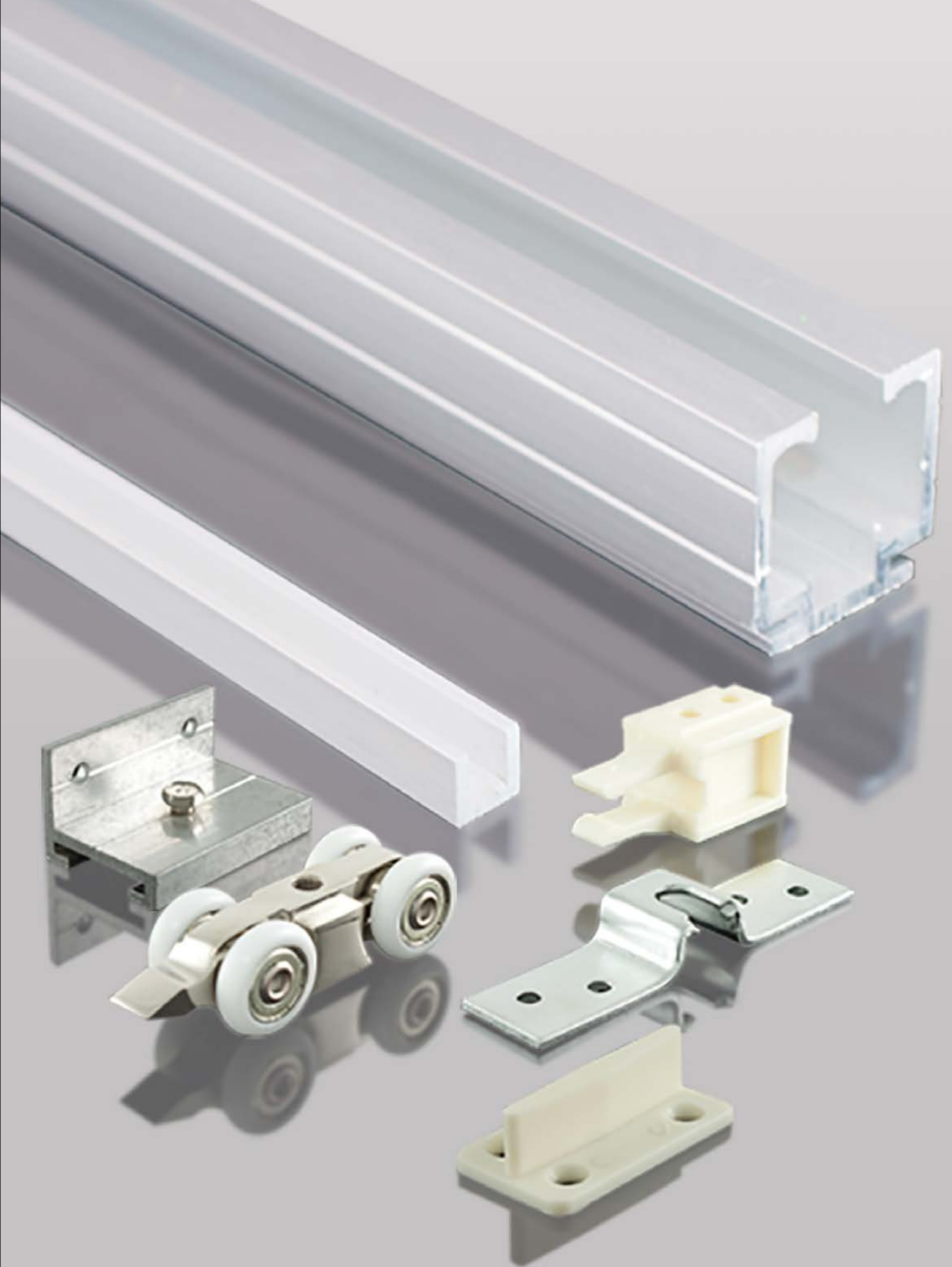

SLIDING RAIL

SIDE INSTALLATION :

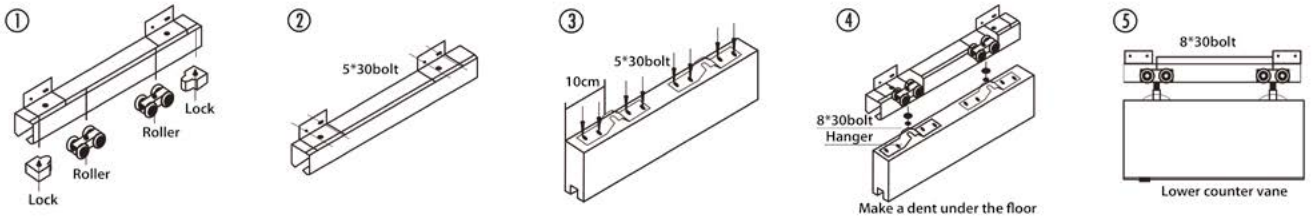

TOP INSTALLATION :

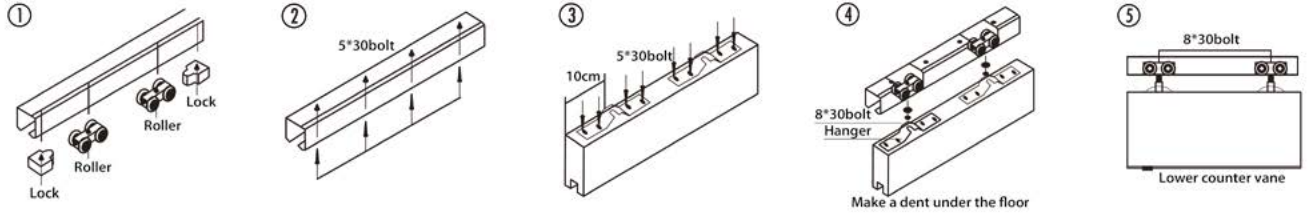

SRP 001
ALUMINIUM
S-1000 (NA)

NOTE :
MEDIUM ALUMINIUM RAIL FOR 1 DOOR
MAXIMUM DOOR WIDTH 110 CM
MAXIMUM DOOR WEIGHT 100 KG
LENGTH OF TOP RAIL 200 CM
LENGTH OF BOTTOM RAIL 100 CM

FEATURES :
- **JAPAN SUPERALUM** MATERIAL.
- HIGH STRENGTH NYLON WHEELS.
- **NSK** JAPAN REAL BEARINGS.
- ULTRA HEAVY DUTY
- LIFETIME MECHANICAL WARRANTY



TOP RAIL 200 CM	BOTTOM RAIL 200 CM	WHEELS + HANGER	STOPPER	TRACK BRACKET	GUIDER "T"	BOLT/SCREW/FISCHER/ KEY"L"/KEY "PAS" VECTOR
1 PC	1 PC	2 PCS	2 PCS	5 PCS	1 PC	1 SET

SRP 002
ALUMINIUM
S-1500 (NA)

NOTE :
LARGE ALUMINIUM RAIL FOR 1 DOOR
MAXIMUM DOOR WIDTH 170 CM
MAXIMUM DOOR WEIGHT 150 KG
LENGTH OF TOP RAIL 300 CM
LENGTH OF BOTTOM RAIL 150 CM

FEATURES :
- **JAPAN SUPERALUM** MATERIAL.
- HIGH STRENGTH NYLON WHEELS.
- **NSK** JAPAN REAL BEARINGS.
- ULTRA HEAVY DUTY
- LIFETIME MECHANICAL WARRANTY



TOP RAIL 300 CM	BOTTOM RAIL 150 CM	WHEELS + HANGER	STOPPER	TRACK BRACKET	GUIDER "T"	BOLT/SCREW/FISCHER/ KEY"L"/KEY "PAS" VECTOR
1 PC	1 PC	2 PCS	2 PCS	7 PCS	1 PC	1 SET

SLIDING RAIL

SRP 003 ALUMINIUM S-2000 (NA)

NOTE :
LARGE ALUMINIUM RAIL FOR 2 DOORS
MAXIMUM DOOR WIDTH 80 CM
MAXIMUM DOOR WEIGHT 75 KG
LENGTH OF TOP RAIL 300 CM
LENGTH OF BOTTOM RAIL 100 CM

FEATURES :
- **JAPAN SUPERALUM** MATERIAL.
- HIGH STRENGTH NYLON WHEELS.
- **NSK** JAPAN REAL BEARINGS.
- ULTRA HEAVY DUTY
- LIFETIME MECHANICAL WARRANTY



TOP RAIL 300 CM	BOTTOM RAIL 100 CM	WHEELS + HANGER	STOPER	TRACK BRACKET	GUIDER "T"	BOLT/SCREW/FISCHER/ KEY"L"/KEY "PAS" VECTOR
1 PC	2 PCS	4 PCS	4 PCS	8 PCS	2 PCS	2 SETS

SRP 004 ALUMINIUM S-900 (NA)

NOTE :
SMALL ALUMINIUM RAIL FOR 1 DOOR
MAXIMUM DOOR WIDTH 100 CM
MAXIMUM DOOR WEIGHT 45 KG
LENGTH OF TOP RAIL 180 CM
LENGTH OF BOTTOM RAIL 90 CM

FEATURES :
- **JAPAN SUPERALUM** MATERIAL.
- 10 YEARS MECHANICAL WARRANTY



TOP RAIL 180 CM	BOTTOM RAIL 90 CM	WHEELS + HANGER	STOPPER	TRACK BRACKET	GUIDER "T"	BOLT/SCREW/FISCHER
1 PC	1 PC	2 PCS	2 PCS	4 PCS	1 PC	1 SET

SRP 005 ALUMINIUM S-1100 (NA)

NOTE :
LARGE ALUMINIUM RAIL FOR 1 DOOR
MAXIMUM DOOR WIDTH 110 CM
MAXIMUM DOOR WEIGHT 150 KG
LENGTH OF TOP RAIL 200 CM
LENGTH OF BOTTOM RAIL 100 CM

FEATURES :
- **JAPAN SUPERALUM** MATERIAL.
- HIGH STRENGTH NYLON WHEELS.
- **NSK** JAPAN REAL BEARINGS.
- ULTRA HEAVY DUTY
- LIFETIME MECHANICAL WARRANTY



TOP RAIL 200 CM	BOTTOM RAIL 100 CM	WHEELS + HANGER	STOPPER	TRACK BRACKET	GUIDER "T"	BOLT/SCREW/FISCHER/ KEY"L"/KEY "PAS" VECTOR
1 PC	1 PC	2 PCS	2 PCS	5 PCS	1 PC	1 SET

SLIDING RAIL

SRP 801

ALUMINIUM
HD3 - 250 (NA)

NOTE :
LARGE ALUMINIUM RAIL FOR 1 DOOR
MAXIMUM DOOR WIDTH 150 CM
MAXIMUM DOOR WEIGHT 250 KG
LENGTH OF TOP RAIL 300 CM
LENGTH OF BOTTOM RAIL 150 CM

FEATURES :
- **JAPAN SUPERALUM** MATERIAL.
- HIGH STRENGTH NYLON WHEELS.
- **NSK** JAPAN REAL BEARINGS.
- ULTRA HEAVY DUTY
- LIFETIME MECHANICAL WARRANTY



TOP RAIL 300 CM	BOTTOM RAIL 150 CM	WHEELS	STOPPER	TRACK BRACKET	GUIDER "T"
1 PC	1 PC	2 PCS	2 PCS	7 PCS	1 PC
HANGER	BOLT/SCREW/FISCHER				
2 PCS	1 SET				

SRP 802

ALUMINIUM
HD4 - 250 (NA)

NOTE :
LARGE ALUMINIUM RAIL FOR 1 DOOR
MAXIMUM DOOR WIDTH 200 CM
MAXIMUM DOOR WEIGHT 250 KG
LENGTH OF TOP RAIL 400 CM
LENGTH OF BOTTOM RAIL 200 CM

FEATURES :
- **JAPAN SUPERALUM** MATERIAL.
- HIGH STRENGTH NYLON WHEELS.
- **NSK** JAPAN REAL BEARINGS.
- ULTRA HEAVY DUTY
- LIFETIME MECHANICAL WARRANTY



TOP RAIL 400 CM	BOTTOM RAIL 200 CM	WHEELS	STOPPER	TRACK BRACKET	GUIDER "T"
1 PC	1 PC	3 PCS	2 PCS	8 PCS	1 PC
HANGER	BOLT/SCREW/FISCHER				
3 PCS	1 SET				

SLIDING RAIL

SRP 901

ALUMINIUM

DBL ACT SOFT (OPEN+CLOSE) 2060-2M

NOTE :

LARGE ALUMINIUM RAIL FOR 1 DOOR
 DOOR WIDTH 65 ~ 100 CM
 MAXIMUM DOOR WEIGHT 60 KG
 LENGTH OF TOP RAIL 200 CM
 LENGTH OF BOTTOM RAIL 100 CM

FEATURES :

- **JAPAN SUPERALUM** MATERIAL.
- HIGH STRENGTH NYLON WHEELS.
- **NSK** JAPAN REAL BEARINGS.
- ULTRA HEAVY DUTY
- 10 YEARS MECHANICAL WARRANTY



TOP RAIL 200 CM	BOTTOM RAIL 100 CM	WHEELS	SOFT BRAKE	TRACK BRACKET	GUIDER "T"	BOLT/SCREW/FISCHER/ KEY"L"/KEY "PAS" VECTOR
1 PC	1 PC	1 PC	1 PC	4 PCS	1 SET	1 SET
ACTIVATOR	HANGER					
2 PCS	2 PCS					

SRP 902

ALUMINIUM

DBL ACT SOFT (OPEN+CLOSE) 2080-2M

NOTE :

LARGE ALUMINIUM RAIL FOR 1 DOOR
 DOOR WIDTH 65 ~ 100 CM
 MAXIMUM DOOR WEIGHT 80 KG
 LENGTH OF TOP RAIL 200 CM
 LENGTH OF BOTTOM RAIL 100 CM

FEATURES :

- **JAPAN SUPERALUM** MATERIAL.
- HIGH STRENGTH NYLON WHEELS.
- **NSK** JAPAN REAL BEARINGS.
- ULTRA HEAVY DUTY
- 10 YEARS MECHANICAL WARRANTY



TOP RAIL 200 CM	BOTTOM RAIL 100 CM	WHEELS	SOFT BRAKE	TRACK BRACKET	GUIDER "T"	BOLT/SCREW/FISCHER/ KEY"L"/KEY "PAS" VECTOR
1 PC	1 PC	1 PC	1 PC	4 PCS	2 SET	1 SET
ACTIVATOR	HANGER					
2 PCS	2 PCS					

PANIC EXIT DEVICE



PANIC EXIT DEVICE SINGLE ENTRY



PDP 501
PANIC EXIT DEVICE 501
STEEL+ALUMINIUM ALLOY
(BLACK+RED)



PANIC EXIT DEVICE DOUBLE ENTRY



PDP 501
PANIC EXIT DEVICE 501
STEEL+ALUMINIUM ALLOY
(BLACK+RED)



PANIC EXIT DEVICE TWO POINT LATCH RIM

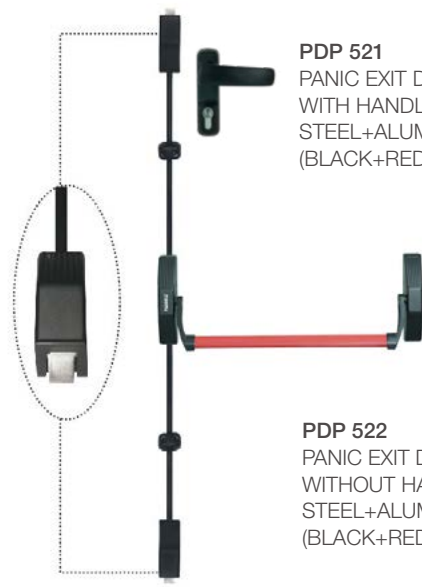

PDP 521
PANIC EXIT DEVICE 521
WITH HANDLE
STEEL+ALUMINIUM ALLOY
(BLACK+RED)

PDP 522
PANIC EXIT DEVICE 522
WITHOUT HANDLE
STEEL+ALUMINIUM ALLOY
(BLACK+RED)

PANIC EXIT DEVICE DOUBLE ENTRY



PDP 511
PANIC EXIT DEVICE 511 WITH HANDLE
STEEL+ALUMINIUM ALLOY
(BLACK+RED)

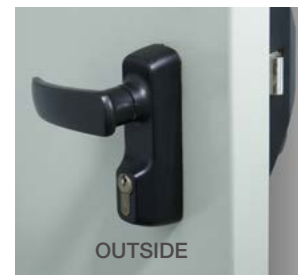

PANIC EXIT DEVICE SINGLE ENTRY



PDP 512
PANIC EXIT DEVICE 512
WITHOUT HANDLE
STEEL+ALUMINIUM ALLOY
(BLACK+RED)



ACCESSORIES FOR STEEL DOOR NON-PANIC DOUBLE ENTRY

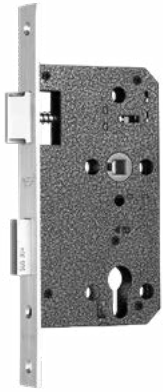

MLP 482
MLP DLX METAL DOOR
SUS 304 (60MM, SSS)



CLP 344
DELUXE DC-SK
BRASS (80MM, SN)



HRP 326
LHT PABLO-22MM SS
SUS 304 (SSS)



BHP 224
DLX 5"X3"X3MM 4BB NRP
SUS 304 (SSS)



DCP 301
DOOR CLOSER 956-NHO
ALUMINIUM (NA)



ACCESSORIES FOR STEEL DOOR PANIC DOUBLE ENTRY

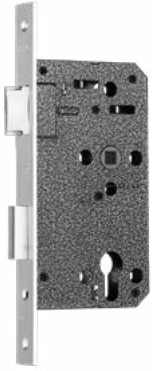

MLP 492
MLP DLX PANIC DOOR
SUS 304 (60MM, SSS)



CLP 344
DELUXE DC-SK
BRASS (80MM, SN)



HRP 326
LHT PABLO-22MM SS
SUS 304 (SSS)



BHP 224
DLX 5*X3*X3MM 4BB NRP
SUS 304 (SSS)



DCP 301
DOOR CLOSER 956-NHO
ALUMINIUM (NA)





MLP 492
MLP DLX PANIC DOOR
SUS 304 (60MM, SSS)



CLP 052
DELUXE HC-SK
BRASS (60MM, SN)



HRP 326
LHT PABLO-22MM SS
SUS 304 (SSS)



FKP 202
FIXED KNOB 202
SUS 304 (SSS)



BHP 224
DLX 5"X3"X3MM 4BB NRP
SUS 304 (SSS)



DCP 301
DOOR CLOSER 956-NHO
ALUMINIUM (NA)





FRP 202
FLUSH RING 202
SUS 304 (SSS)



LSP 201
LATCH FOR SHAFT 201
SUS 304 (60MM, SSS)



BHP 221
DLX 3\"X2.5\"X2MM 2BB NRP
SUS 304 (SSS)



DBP 221
DOOR BOLT 203
SUS 304 (SSS)



PALOMA[®]
HIGH QUALITY ARCHITECTURAL HARDWARE

WWW.PALOMAHARDWARE.COM

