

PALOMA[®]

HIGH QUALITY ARCHITECTURAL HARDWARE



Excellent
Smart Digital Lock





PALOMA[®]

HIGH QUALITY ARCHITECTURAL HARDWARE

Digital Lock 6000



2020-01-01
12:00

- 1
- 2
- 3
- 4
- 5
- 6
- 7
- 8
- 9
- 0
- *
- Lock icon
- Unlock icon

PALOMA



3D Face Recognition

Recognize faces quickly and accurately.

Video Call

Can make video calls via cell phone.

RECHARGEABLE LITHIUM BATTERY

The battery can be recharged using a charger or power bank with a micro-USB cable.



Digital Lock 6000

DLP 6000: Gunmetal (Tuya Wi-Fi) DLP 6000D: Gunmetal (Dummy)

Door Thickness:
40mm - 100mm

Door Frame:
Min. 100mm

Capacity Admin & User

Face Recognition : max 50
Fingerprint : max 50
RFID Card : max 250
PIN Code : max 250



Specification

- Panel material: Aluminium alloy
- Mortise: Full stainless steel SUS 304, backset 60mm
- Cylinder & Key: Full brass, high security grade
- Fingerprint sensor: Semiconductor capacitive (FPC Sweden)
- RFID reader: Non-contact induction (MIFARE 1K 13.56 Mhz)
- Numpad: Touchscreen
- Power Backup Port: Micro-USB
- Voltage: DC 4.5 - 6.0 V
- Operating Temperature: -10°C - 60°C
- Operating Humidity: 10% - 95% RH

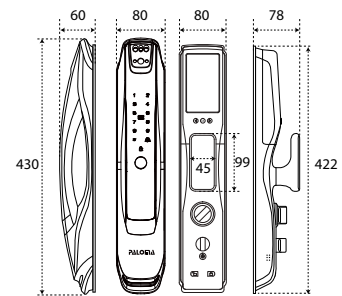

Features

Multiple Access

- Face Recognition
- Smartphone App (Android & iOS)
- Fingerprint
- PIN Code
- RFID Card: MIFARE 13.56 Mhz
- Mechanical Key

High Security

- Automatic Locking
- Mortise Full SUS 304
- With Privacy Deadbolt
- Hardened Solid Deadbolt
- High Security Cylinder & Key
- Dual Verification Mode
- Anti-Theft Fake PIN
- Anti-Burglar Alarm
- Dust & Splash Proof

User Management

- 10 Admins & 240 Users
- Unlocking Records & Notification

Easy Operation

- Camera as Door Viewer
- Video Call
- Touch Screen
- Passage Mode
- Doorbell

Battery

- Rechargeable Lithium Battery (x2)
- Low Battery Notification
- Micro-USB Backup Port

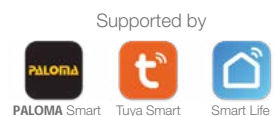
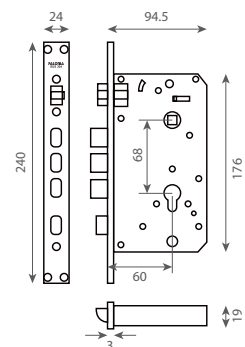

PALOMA[®]

HIGH QUALITY ARCHITECTURAL HARDWARE

Digital Lock 415



PALOMA

Digital Lock 415

DLP 415B: Black (Tuya Wi-Fi)

Door Thickness:
30mm - 70mm

Door Frame:
Min. 95mm

Capacity Admin & User

Fingerprint : max 100
RFID Card : max 300
PIN Code : max 300

Fingerprint
+ RFID Card
+ PIN Code : max 300



Specification

- Panel material: Zamak alloy
- Mortise: Deadbolt type, backset adjustable 60/70mm
- Cylinder & Key: Full brass
- Fingerprint sensor: Semiconductor capacitive (FPC Sweden)
- RFID reader: Non-contact induction (MIFARE 1K 13.56 Mhz)
- Numpad: Touchscreen
- Power Backup Port: Type-C
- Voltage: DC 5.0 - 6.0 V
- Operating Temperature: -20°C ~ 70°C
- Operating Humidity: 20% ~ 80% RH

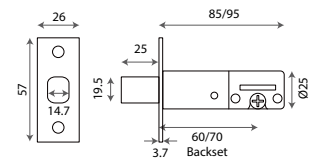
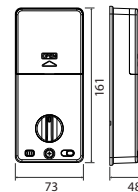
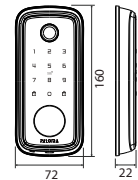

Features

Multiple Access

- Smartphone App (Android & iOS)
- Fingerprint
- PIN Code
- RFID Card: MIFARE 13.56 Mhz
- Mechanical Key

User Management

- 9 Admins & 291 Users
- Unlocking Records & Notification

Easy Operation

- Touch Screen
- Passage Mode
- Magnetic Sensor (Optional)

High Security

- Automatic Locking
- Mortise SUS 304
- With Privacy Button
- Hardened Solid Deadbolt
- Dual Verification Mode
- Anti-Theft Fake PIN
- Dust & Splash Proof

Battery

- Low Battery Notification
- Alkaline AA x 4pcs
- Type-C Backup Port

Supported by



Digital Lock 415

DLP 415S: Silver (Tuya Wi-Fi)

Door Thickness:
30mm - 70mm

Door Frame:
Min. 95mm

Capacity Admin & User

Fingerprint : max 100
RFID Card : max 300
PIN Code : max 300

Fingerprint
+ RFID Card
+ PIN Code : max 300



Specification

- Panel material: Zamak alloy
- Mortise: Deadbolt type, backset adjustable 60/70mm
- Cylinder & Key: Full brass
- Fingerprint sensor: Semiconductor capacitive (FPC Sweden)
- RFID reader: Non-contact induction (MIFARE 1K 13.56 Mhz)
- Numpad: Touchscreen
- Power Backup Port: Type-C
- Voltage: DC 5.0 - 6.0 V
- Operating Temperature: -20°C - 70°C
- Operating Humidity: 20% - 80% RH

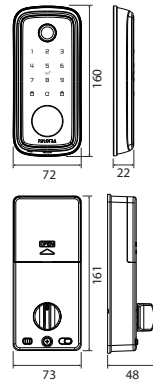

Features

Multiple Access

- Smartphone App (Android & iOS)
- Fingerprint
- PIN Code
- RFID Card: MIFARE 13.56 Mhz
- Mechanical Key

User Management

- 9 Admins & 291 Users
- Unlocking Records & Notification

Easy Operation

- Touch Screen
- Passage Mode
- Magnetic Sensor (Optional)

High Security

- Automatic Locking
- Mortise SUS 304
- With Privacy Button
- Hardened Solid Deadbolt
- Dual Verification Mode
- Anti-Theft Fake PIN
- Dust & Splash Proof

Battery

- Low Battery Notification
- Alkaline AA x 4pcs
- Type-C Backup Port

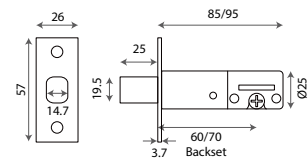

Supported by



PALOMA[®]

HIGH QUALITY ARCHITECTURAL HARDWARE

Digital Lock 4100



1 2 3
4 5 6
7 8 9
🔒 0 🔒

PALOMA

PALOMA 010



Digital Lock 4100

DLP 4121: Matte Black (Tuya Wi-Fi)



Specification

- Panel material: Aluminium alloy, acrylic
- Mortise: Deadbolt type, backset adjustable 60/70mm
- Cylinder & Key: Full brass, 5 security pins
- Fingerprint sensor: Semiconductor capacitive (FPC Sweden)
- RFID reader: Non-contact induction (MIFARE 1K 13.56 Mhz)
- Numpad: Touchscreen
- Power Backup Port: Micro-USB
- Voltage: DC 4.5 - 6.0 V
- Operating Temperature: -10°C - 60°C
- Operating Humidity: 10% - 95% RH

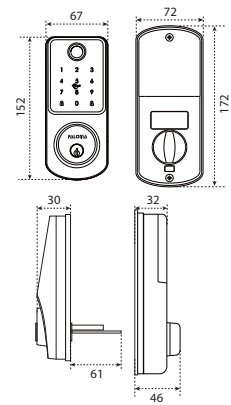

Features

Multiple Access

- Smartphone App (Android & iOS)
- Fingerprint
- PIN Code
- RFID Card: MIFARE 13.56 Mhz
- Mechanical Key

High Security

- Automatic Locking
- Mortise SUS 304
- With Privacy Button
- Hardened Solid Deadbolt
- Dual Verification Mode
- Anti-Theft Fake PIN
- Dust & Splash Proof

User Management

- 9 Admins & 291 Users
- 10 Repeat Schedule Users
- Unlocking Records & Notification

Battery

- Low Battery Notification
- Alkaline AA x 4pcs
- Micro-USB Backup Port

Easy Operation

- Touch Screen
- Passage Mode
- Magnetic Sensor (Optional)

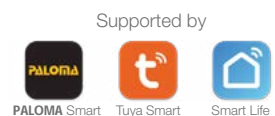
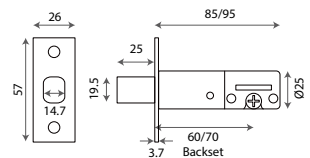

PALOMA[®]

HIGH QUALITY ARCHITECTURAL HARDWARE

Smart Cylinder

701



DLP 701B: Black (Tuya Bluetooth)



Battery CR123A (not included)



Reset Cards



RFID Cards



Keys



Rubber Suction



Capacity Admin & User

Fingerprint : max 100
 RFID Card : max 200

Fingerprint + RFID Card : max 200

Specification

- Panel material: Aluminium alloy, brass and stainless steel SUS 304
- Cylinder & Key: Full brass, high security grade
- Fingerprint sensor: Semiconductor capacitive (FPC Sweden)
- RFID reader: Non-contact induction (MIFARE 1K 13.56 Mhz)
- Power Backup Port: Type-C
- Voltage: DC 4.5 - 6.0 V
- Operating Temperature: -10°C - 60°C
- Operating Humidity: 10% - 95% RH

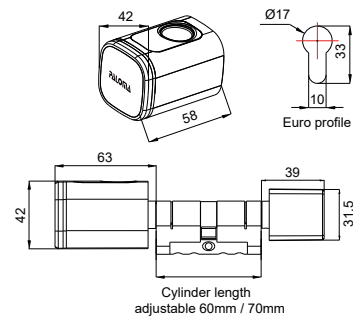

Features

Multiple Access

- Smartphone App (Android & iOS)
- Fingerprint
- RFID Card: MIFARE 13.56 Mhz
- Mechanical Key

High Security

- High Security Cylinder
- High Security Mechanical Key
- Dual Verification Mode

User Management

- 200 Total Access Points
- Admin & User
- Unlocking Records & Notification

Battery

- Lithium Battery CR123A x 1pc
- Low Battery Notification
- Type-C Backup Port

Easy Operation

- Passage Mode
- Easy Installation
- Cylinder Length Adjustable 60/70mm
- TUYA Gateway Ready (not included)

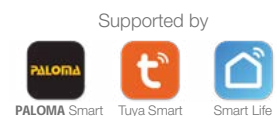

Smart Cylinder 701

DLP 701S: Silver (Tuya Bluetooth)



Capacity Admin & User

Fingerprint : max 100
RFID Card : max 200

Fingerprint + RFID Card : max 200

Specification

- Panel material: Aluminium alloy, brass and stainless Steel SUS 304
- Cylinder & Key: Full brass, high security grade
- Fingerprint sensor: Semiconductor capacitive (FPC Sweden)
- RFID reader: Non-contact induction (MIFARE 1K 13.56 Mhz)
- Power Backup Port: Type-C
- Voltage: DC 4.5 - 6.0 V
- Operating Temperature: -10°C - 60°C
- Operating Humidity: 10% - 95% RH

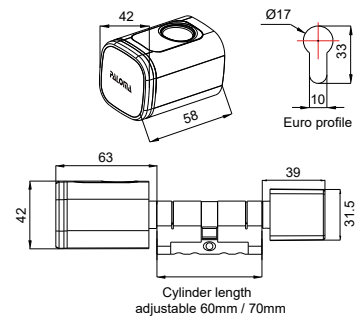

Features

Multiple Access

- Smartphone App (Android & iOS)
- Fingerprint
- RFID Card: MIFARE 13.56 Mhz
- Mechanical Key

High Security

- High Security Cylinder
- High Security Mechanical Key
- Dual Verification Mode

User Management

- 200 Total Access Points
- Admin & User
- Unlocking Records & Notification

Battery

- Lithium Battery CR123A x 1pc
- Low Battery Notification
- Type-C Backup Port

Easy Operation

- Passage Mode
- Easy Installation
- Cylinder Length Adjustable 60/70mm
- TUYA Gateway Ready (not included)

Supported by



PALOMA[®]

HIGH QUALITY ARCHITECTURAL HARDWARE

Digital Lock

2100

Series



SMART LOCK



SEMICONDUCTOR BIOMETRIC

Fast fingerprint identification.

Accurate reading in all orientation 360°.

HIGH HARDNESS TEMPERED GLASS

Tough and scratch
resistant.









CHILD-PROOF INSIDE HANDLE

FINGERPRINT ON HANDLE



USB TYPE-C BACKUP PORT



**DIGITAL LOCK
WITH CAMERA
AS DOOR VIEWER**

**SEND GUEST PHOTO
TO PHONE**



Digital Lock 2100

DLP 2138: Black (Tuya Wi-Fi)



Specification

- Panel material: Aluminium alloy, tempered glass
- Mortise: Full stainless steel SUS 304, backset 60mm
- Cylinder & Key: Full brass, high security grade
- Fingerprint sensor: Semiconductor capacitive (FPC Sweden)
- RFID reader: Non-contact induction (MIFARE 1K 13.56 Mhz)
- Numpad: Touchscreen
- Power Backup Port: Micro-USB
- Voltage: DC 4.5 - 6.0 V
- Operating Temperature: -10°C - 60°C
- Operating Humidity: 10% - 95% RH

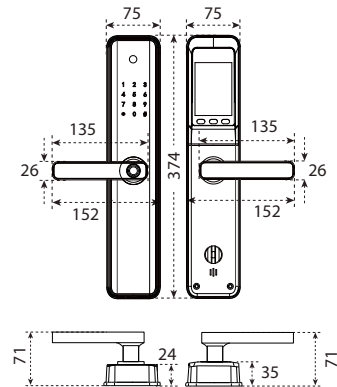

Features

Multiple Access

- Smartphone App (Android & iOS)
- Fingerprint
- PIN Code
- RFID Card: MIFARE 13.56 Mhz
- Mechanical Key

User Management

- 9 Admins & 291 Users
- 10 Repeat Schedule Users
- Unlocking Records & Notification

Easy Operation

- Camera as Door Viewer
- Send Guest Photo to Phone
- Turn Up Handle for Deadbolt
- Passage Mode

High Security

- Automatic Locking
- Mortise Full SUS 304
- With Privacy Deadbolt
- Hardened Solid Deadbolt
- High Security Cylinder & Key
- Dual Verification Mode
- Anti-Theft Fake PIN
- Anti-Burglar Alarm
- Dust & Splash Proof

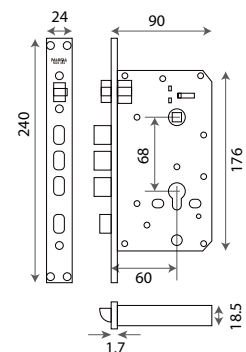

Battery

- Low Battery Notification
- Alkaline AA x 4pcs or 8pcs
- Micro-USB Backup Port

Supported by



DLP 2131: Black (Tuya Wi-Fi)
DLP 2136: Black (No App)

Door Thickness:
32mm - 130mm

Door Frame:
Min. 105mm

Capacity Admin & User

Fingerprint : max 100
 RFID Card : max 300
 PIN Code : max 300

Fingerprint
 + RFID Card
 + PIN Code : max 300



Specification

- Panel material: Aluminium alloy, tempered glass
- Mortise: Full stainless steel SUS 304, backset 60mm
- Cylinder & Key: Full brass, high security grade
- Fingerprint sensor: Semiconductor capacitive (FPC Sweden)
- RFID reader: Non-contact induction (MIFARE 1K 13.56 Mhz)
- Numpad: Touchscreen
- Power Backup Port: Micro-USB
- Voltage: DC 4.5 - 6.0 V
- Operating Temperature: -10°C - 60°C
- Operating Humidity: 10% - 95% RH

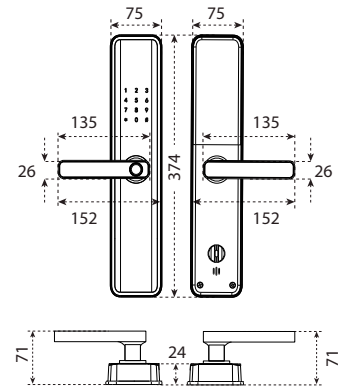

Features

Multiple Access

- Smartphone App (Android & iOS)
- Fingerprint
- PIN Code
- RFID Card: MIFARE 13.56 Mhz
- Mechanical Key

User Management

- 9 Admins & 291 Users
- 10 Repeat Schedule Users
- Unlocking Records & Notification

Easy Operation

- Fingerprint on Handle
- Touch Screen
- Turn Up Handle for Deadbolt
- Passage Mode

High Security

- Automatic Locking
- Mortise Full SUS 304
- With Privacy Deadbolt
- Hardened Solid Deadbolt
- High Security Cylinder & Key
- Dual Verification Mode
- Anti-Theft Fake PIN
- Anti-Burglar Alarm
- Dust & Splash Proof

Battery

- Low Battery Notification
- Alkaline AA x 4pcs or 8pcs
- Micro-USB Backup Port

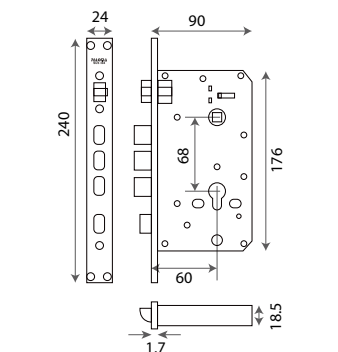

Supported by



Digital Lock 2100

DLP 2101: Titanium Grey (Tuya Wi-Fi)



Specification

- Panel material: Aluminium alloy, polycarbonate
- Mortise: Full stainless steel SUS 304, backset 60mm
- Cylinder & Key: Full brass, high security grade
- Fingerprint sensor: Semiconductor capacitive (FPC Sweden)
- RFID reader: Non-contact induction (MIFARE 1K 13.56 Mhz)
- Numpad: Touchscreen
- Power Backup Port: USB type-C
- Voltage: DC 4.5 - 6.0 V
- Operating Temperature: -10°C - 60°C
- Operating Humidity: 10% - 95% RH

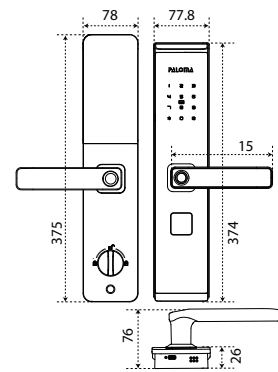

Features

Multiple Access

- Smartphone App (Android & iOS)
- Fingerprint
- PIN Code
- RFID Card: MIFARE 13.56 Mhz
- Mechanical Key

User Management

- 9 Admins & 291 Users
- 10 Temporary Users
- Unlocking Records & Notification

Easy Operation

- Fingerprint on Handle
- Touch Screen
- Turn Up Handle for Deadbolt
- Passage Mode

High Security

- Automatic Locking
- Mortise Full SUS 304
- With Privacy Deadbolt
- Hardened Solid Deadbolt
- High Security Cylinder & Key
- Dual Verification Mode
- Anti-Theft Fake PIN
- Anti-Burglar Alarm
- Child Proof Inside Handle
- Dust & Splash Proof

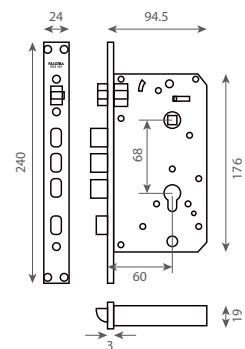

Battery

- Low Battery Notification
- Alkaline AA x 4pcs
- USB Type-C Backup Port

Supported by



PALOMA[®]

HIGH QUALITY ARCHITECTURAL HARDWARE

Digital Lock

3100



1 2 3
4 5 6
7 8 9
* 0 #

PALOMA



Digital Lock 3100

DLP 3121: Black (Tuya Wi-Fi)

Door Thickness:
33mm - 60mm

Door Frame:
Min. 85mm

Capacity Admin & User

Fingerprint : max 100
RFID Card : max 300
PIN Code : max 300

Fingerprint
+ RFID Card
+ PIN Code : max 300



Specification

- Panel material: Aluminium alloy, tempered glass
- Mortise: Stainless steel SUS 304, backset 50mm
- Cylinder & Key: Full brass, high security grade
- Fingerprint sensor: Semiconductor capacitive (FPC Sweden)
- RFID reader: Non-contact induction (MIFARE 1K 13.56 Mhz)
- Numpad: Touchscreen
- Power Backup Port: Micro-USB
- Voltage: DC 4.5 - 6.0 V
- Operating Temperature: -10°C - 60°C
- Operating Humidity: 10% - 95% RH

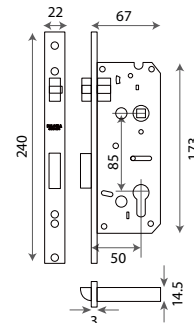
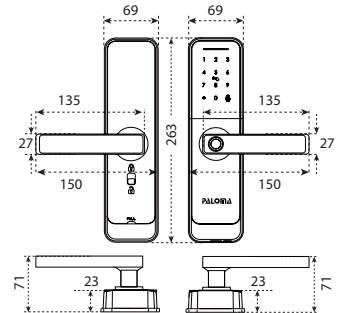

Features

Multiple Access

- Smartphone App (Android & iOS)
- Fingerprint
- PIN Code
- RFID Card: MIFARE 13.56 Mhz
- Mechanical Key

User Management

- 9 Admins & 291 Users
- 10 Repeat Schedule Users
- Unlocking Records & Notification

Easy Operation

- Fingerprint on Handle
- Turn Up Handle for Deadbolt
- Passage Mode
- Door Bell

High Security

- Automatic Locking
- Mortise SUS 304
- With Privacy Toggle
- Hardened Solid Deadbolt
- High Security Cylinder & Key
- Dual Verification Mode
- Anti-Theft Fake PIN
- Dust & Splash Proof

Battery

- Low Battery Notification
- Alkaline AA x 4pcs
- Micro-USB Backup Port

Supported by



PALOMA[®]

HIGH QUALITY ARCHITECTURAL HARDWARE

Digital Lock 516



DLP 516B: Black (Tuya Wi-Fi)

Door Thickness:
35mm - 70mm

Door Frame:
Min. 55mm

Capacity Admin & User

Fingerprint : max 100
RFID Card : max 300
PIN Code : max 300

Fingerprint
+ RFID Card
+ PIN Code : max 300

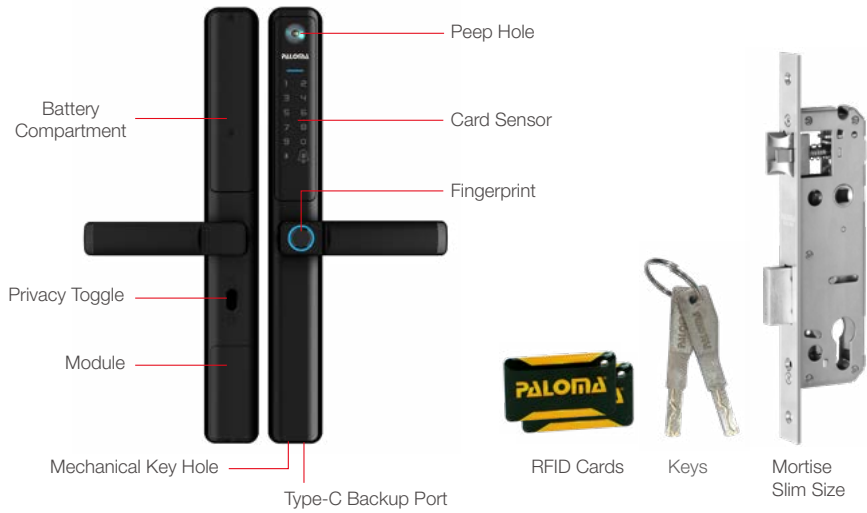

Specification

- Panel material: Aluminium alloy, tempered glass
- Mortise: Stainless steel SUS 304, backset 35mm
- Cylinder & Key: Full brass, high security grade
- Fingerprint sensor: Semiconductor capacitive (FPC Sweden)
- RFID reader: Non-contact induction (MIFARE 1K 13.56 Mhz)
- Numpad: Touchscreen
- Power Backup Port: Type-C
- Voltage: DC 4.5 - 6.0 V
- Operating Temperature: -20°C - 50°C
- Operating Humidity: 10% - 95% RH

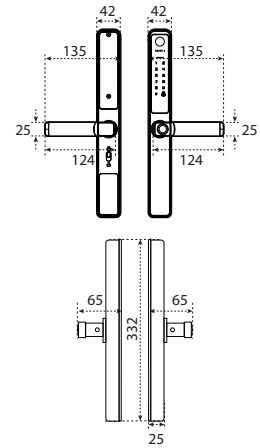

Features

Multiple Access

- Smartphone App (Android & iOS)
- Fingerprint
- PIN Code
- RFID Card: MIFARE 13.56 Mhz
- Mechanical Key

User Management

- 9 Admins & 291 Users
- Unlocking Records & Notification

Easy Operation

- Turn Up Handle for Deadbolt
- Passage Mode
- Door Bell

High Security

- Automatic Locking
- With Privacy Toggle
- Mortise SUS 304
- Hardened Solid Deadbolt
- High Security Cylinder & Key
- Dual Verification Mode
- Anti-Theft Fake PIN
- Dust & Splash Proof

Battery

- Low Battery Notification
- Alkaline AA x 4pcs
- Type-C Backup Port

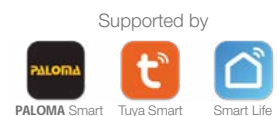
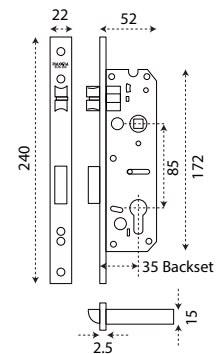

DLP 516S: Silver (Tuya Wi-Fi)

Door Thickness:
35mm - 70mm

Door Frame:
Min. 55mm

Capacity Admin & User

Fingerprint : max 100
RFID Card : max 300
PIN Code : max 300

Fingerprint
+ RFID Card
+ PIN Code : max 300

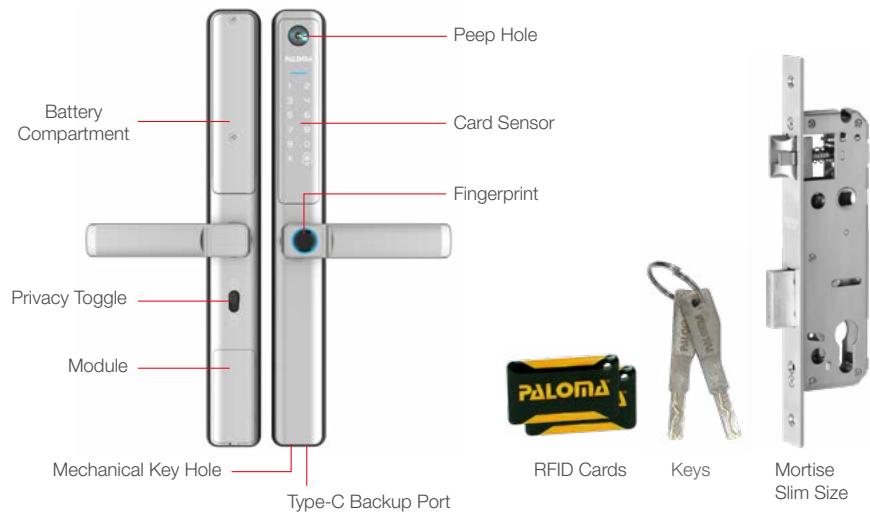

Specification

- Panel material: Aluminium alloy, tempered glass
- Mortise: Stainless steel SUS 304, backset 35mm
- Cylinder & Key: Full brass, high security grade
- Fingerprint sensor: Semiconductor capacitive (FPC Sweden)
- RFID reader: Non-contact induction (MIFARE 1K 13.56 Mhz)
- Numpad: Touchscreen
- Power Backup Port: Type-C
- Voltage: DC 4.5 - 6.0 V
- Operating Temperature: -20°C - 50°C
- Operating Humidity: 10% - 95% RH

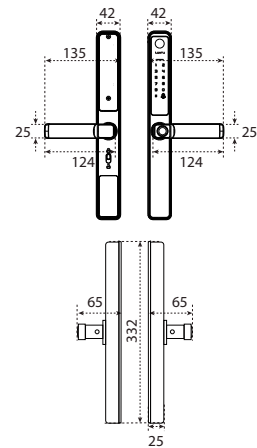

Features

Multiple Access

- Smartphone App (Android & iOS)
- Fingerprint
- PIN Code
- RFID Card: MIFARE 13.56 Mhz
- Mechanical Key

User Management

- 9 Admins & 291 Users
- Unlocking Records & Notification

Easy Operation

- Turn Up Handle for Deadbolt
- Passage Mode
- Door Bell

High Security

- Automatic Locking
- With Privacy Toggle
- Mortise SUS 304
- Hardened Solid Deadbolt
- High Security Cylinder & Key
- Dual Verification Mode
- Anti-Theft Fake PIN
- Dust & Splash Proof

Battery

- Low Battery Notification
- Alkaline AA x 4pcs
- Type-C Backup Port

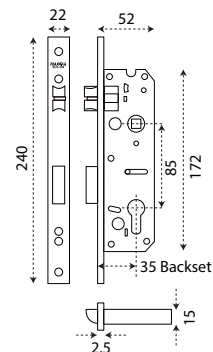

Supported by



PALOMA[®]

HIGH QUALITY ARCHITECTURAL HARDWARE

Digital Lock

5100



PALOMA



- 1 2
- 3 4
- 5 6
- 7 8
- 9 0
- * #



DLP 5121: Matte Black (Tuya Wi-Fi)

Door Thickness:
30mm - 60mm

Door Frame:
Min. 51mm

Capacity Admin & User

Fingerprint : max 100
RFID Card : max 300
PIN Code : max 300

Fingerprint
+ RFID Card
+ PIN Code : max 300



Specification

- Panel material: Full stainless steel SUS 304, acrylic
- Mortise: Stainless steel SUS 304, backset 30mm
- Cylinder & Key: Full brass, high security grade
- Fingerprint sensor: Semiconductor capacitive (FPC Sweden)
- RFID reader: Non-contact induction (MIFARE 1K 13.56 Mhz)
- Numpad: Touchscreen
- Power Backup Port: Micro-USB
- Voltage: DC 4.5 - 6.0 V
- Operating Temperature: -10°C - 60°C
- Operating Humidity: 10% - 95% RH

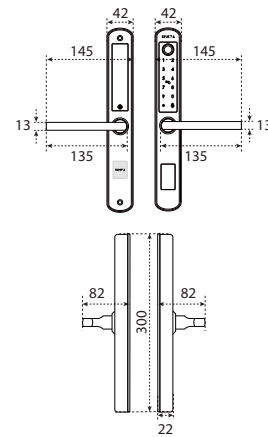

Features

Multiple Access

- Smartphone App (Android & iOS)
- Fingerprint
- PIN Code
- RFID Card: MIFARE 13.56 Mhz
- Mechanical Key

High Security

- Automatic Locking
- Mortise SUS 304
- Hardened Solid Deadbolt
- High Security Cylinder & Key
- Dual Verification Mode
- Anti-Theft Fake PIN
- Dust & Splash Proof

User Management

- 9 Admins & 291 Users
- 10 Repeat Schedule Users
- Unlocking Records & Notification

Battery

- Low Battery Notification
- Alkaline AAA x 4pcs
- Micro-USB Backup Port

Easy Operation

- Turn Up Handle for Deadbolt
- Passage Mode
- Door Bell

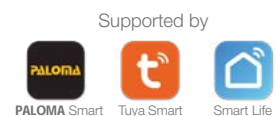
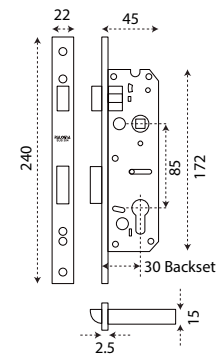

Digital Lock 5100

DLP 5122: Satin + Polished (Tuya Wi-Fi)

Door Thickness:
30mm - 60mm

Door Frame:
Min. 51mm

Capacity Admin & User

Fingerprint : max 100
RFID Card : max 300
PIN Code : max 300

Fingerprint
+ RFID Card
+ PIN Code : max 300



Specification

- Panel material: Full stainless steel SUS 304, acrylic
- Mortise: Stainless steel SUS 304, backset 30mm
- Cylinder & Key: Full brass, high security grade
- Fingerprint sensor: Semiconductor capacitive (FPC Sweden)
- RFID reader: Non-contact induction (MIFARE 1K 13.56 Mhz)
- Numpad: Touchscreen
- Power Backup Port: Micro-USB
- Voltage: DC 4.5 - 6.0 V
- Operating Temperature: -10°C - 60°C
- Operating Humidity: 10% - 95% RH

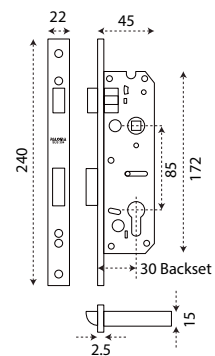
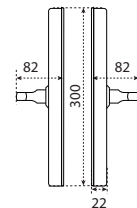
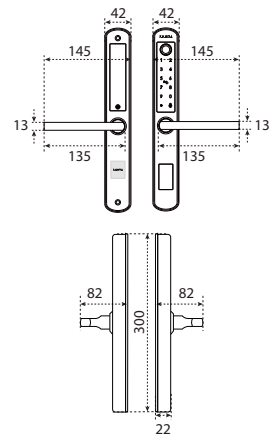

Features

Multiple Access

- Smartphone App (Android & iOS)
- Fingerprint
- PIN Code
- RFID Card: MIFARE 13.56 Mhz
- Mechanical Key

High Security

- Automatic Locking
- Mortise SUS 304
- Hardened Solid Deadbolt
- High Security Cylinder & Key
- Dual Verification Mode
- Anti-Theft Fake PIN
- Dust & Splash Proof

User Management

- 9 Admins & 291 Users
- 10 Repeat Schedule Users
- Unlocking Records & Notification

Battery

- Low Battery Notification
- Alkaline AAA x 4pcs
- Micro-USB Backup Port

Easy Operation

- Turn Up Handle for Deadbolt
- Passage Mode
- Door Bell

Supported by





